

A modern, minimalist bench with a vibrant red upholstered seat and backrest. The bench features a white metal frame with a flat top surface and four thin, slightly curved legs. The background is a plain, light color, creating a clean and professional look.

Business center

brighten your business

MOVING



MOVING

Business Center



MOVING TECHNOLOGY ITALIAN STYLE



Bohème 4



Aida 10



Zaira 16



Tosca 20



Carmen 26



Cardinale 30



Arturo 34



Modulo 42



Elettra 46



Nabucco 50



Otello 56



Edgar 60

Dimensions 64

Rivestimenti
Upholstery 70

Design_AZ Creations



MOVING



Bohème





BH02



BH04



BH10



BH16



BH07



BH09



BH17





Design_AZ Creations

 MOVING



Aida





DA06



DA02



DA10



DA13



DA04



DA07



DA16



Design_AZ Creations

 MOVING

Zaira





ZA06



ZA04



ZA02



ZA10

Design_AZ Creations

 MOVING



Tosca





TA02



TA04



TA01



TA03



TA05





Design_AZ Creations



MOVING

Carmen





RN01



RN03



RN04



RN02

Design_AZ Creations

 MOVING



Cardinale





ZZ01 - CA01



CA05



CA02



CA06



Design_AZ Creations

 MOVING



Arturo



AH01





AH02

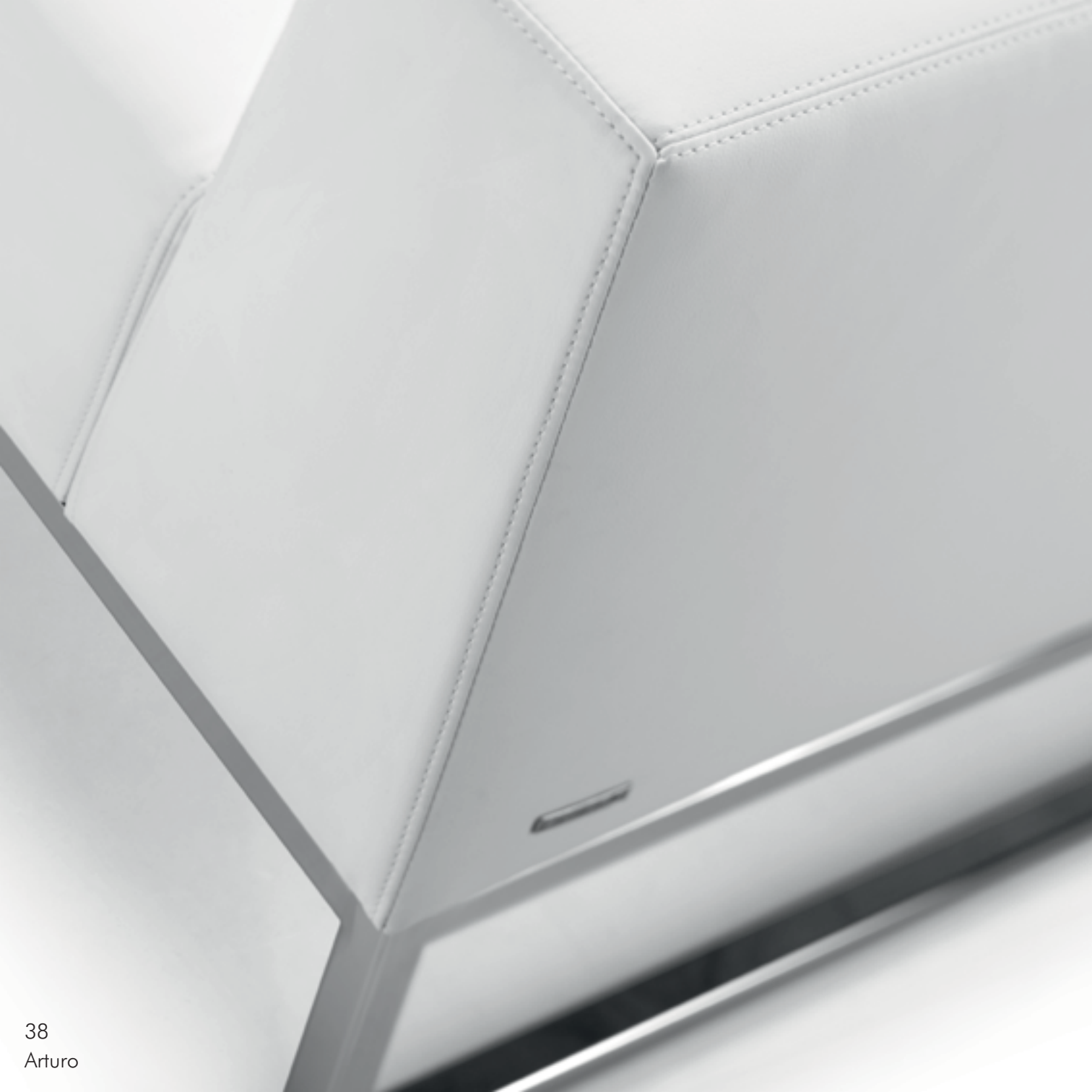



AH03







Design_Arch. Pierluigi Galassi

 MOVING



Modulo





MLO3



MLO2



MLO1

Design_AZ Creations

 MOVING



Elettra





LC01

Design_AZ Creations

 MOVING



Nabucco





NA04



NA03



NA02



NA01





Design_AZ Creations

 MOVING

Otello





OT02



OT03



OT04



OT01

Design_AZ Creations



MOVING



Edgar





ED02



ED03



ED04



ED01

Dimensioni/Dimensions

Bohème

Aida

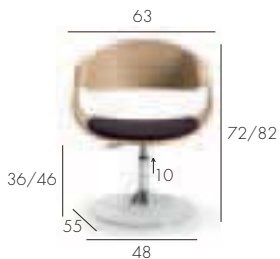
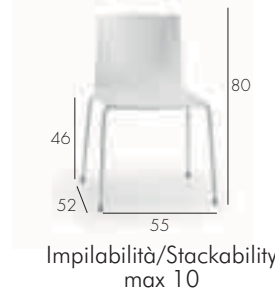
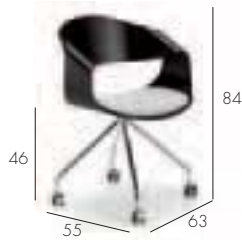
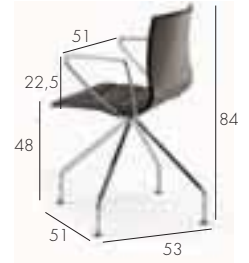
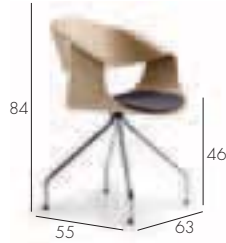

Dimensioni/Dimensions

Zaira



Impilabilità/Stackability
max 10

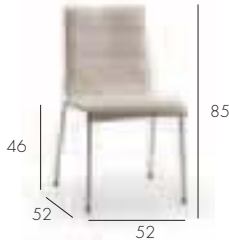

Impilabilità/Stackability
max 8



Impilabilità/Stackability
max 6

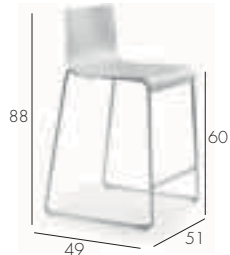

Impilabilità/Stackability
max 8

Tosca

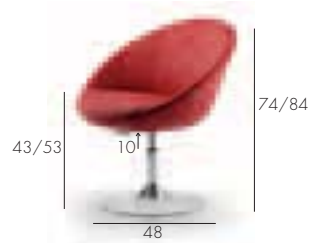
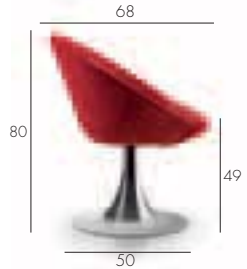

Dimensioni/Dimensions

Carmen

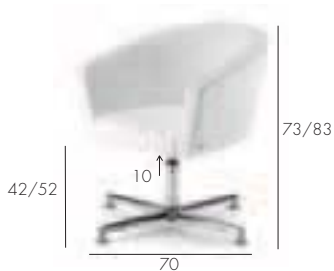
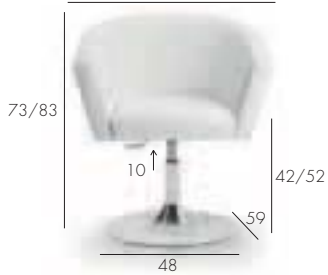

Cardinale



Dimensioni/Dimensions

Arturo

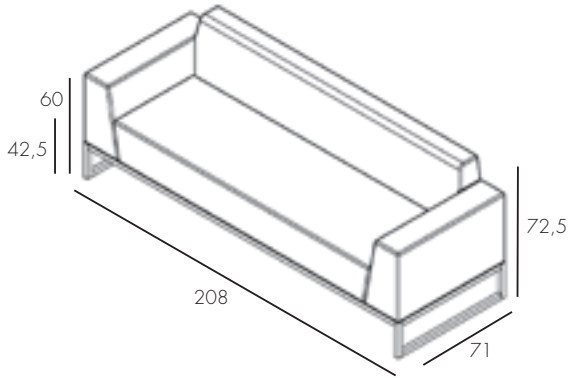
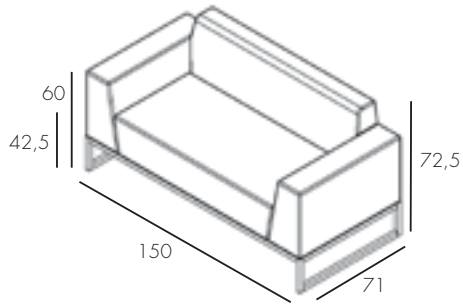
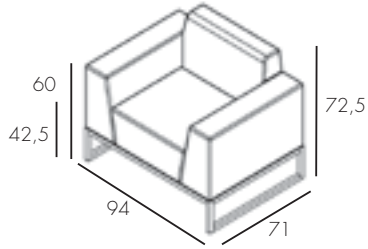

Modulo

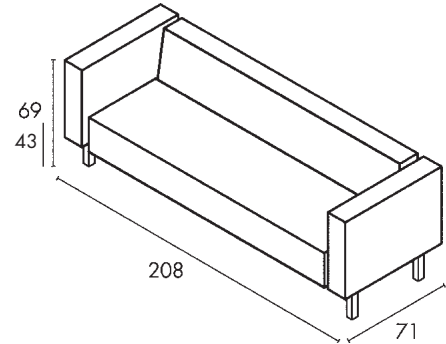
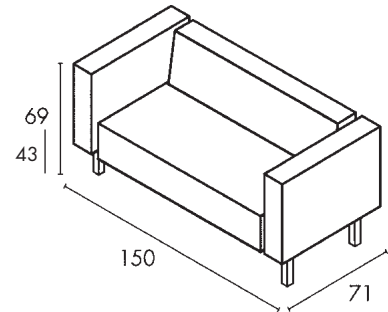
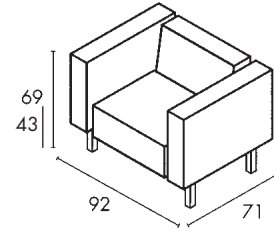

Dimensioni/Dimensions

Elettra

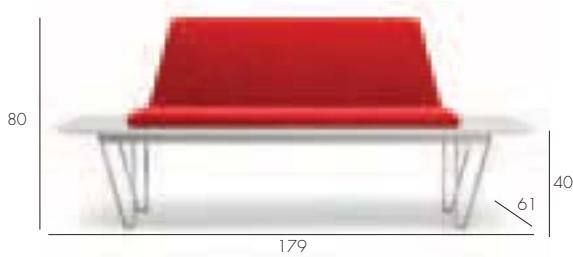

Nabucco

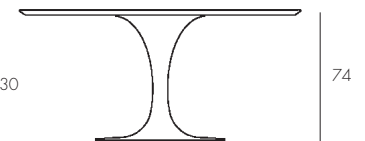
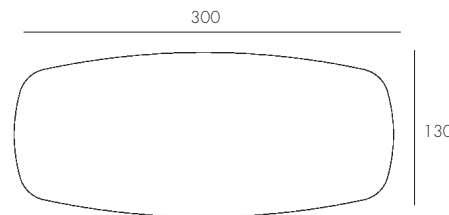
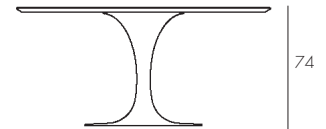
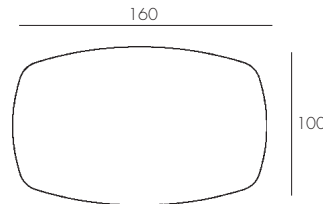
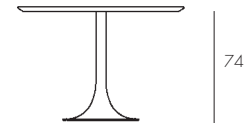
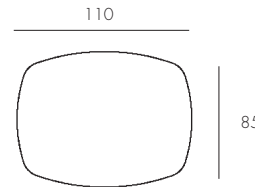
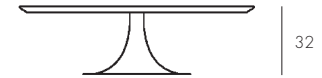
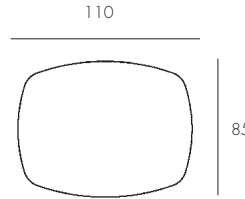

Dimensioni/Dimensions

Otello

Edgar

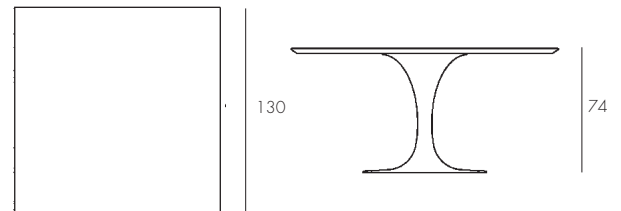
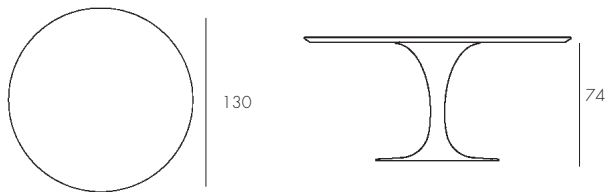
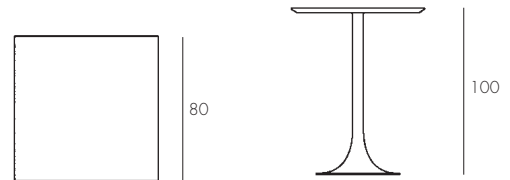
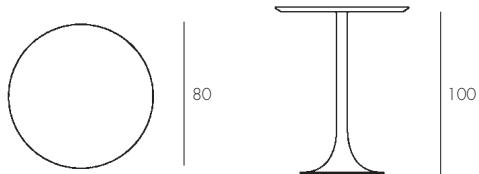
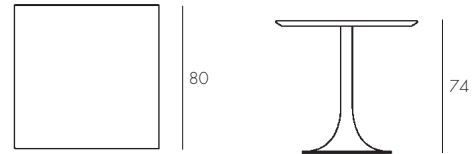
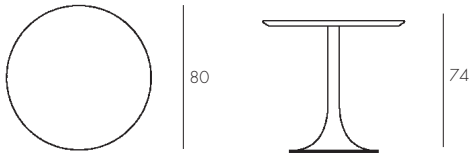
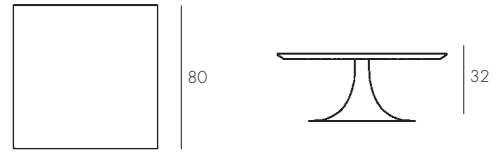
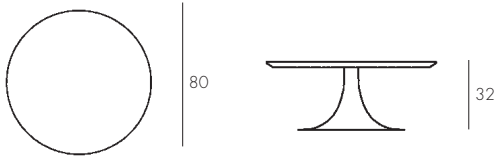

Rivestimenti/Upholstery

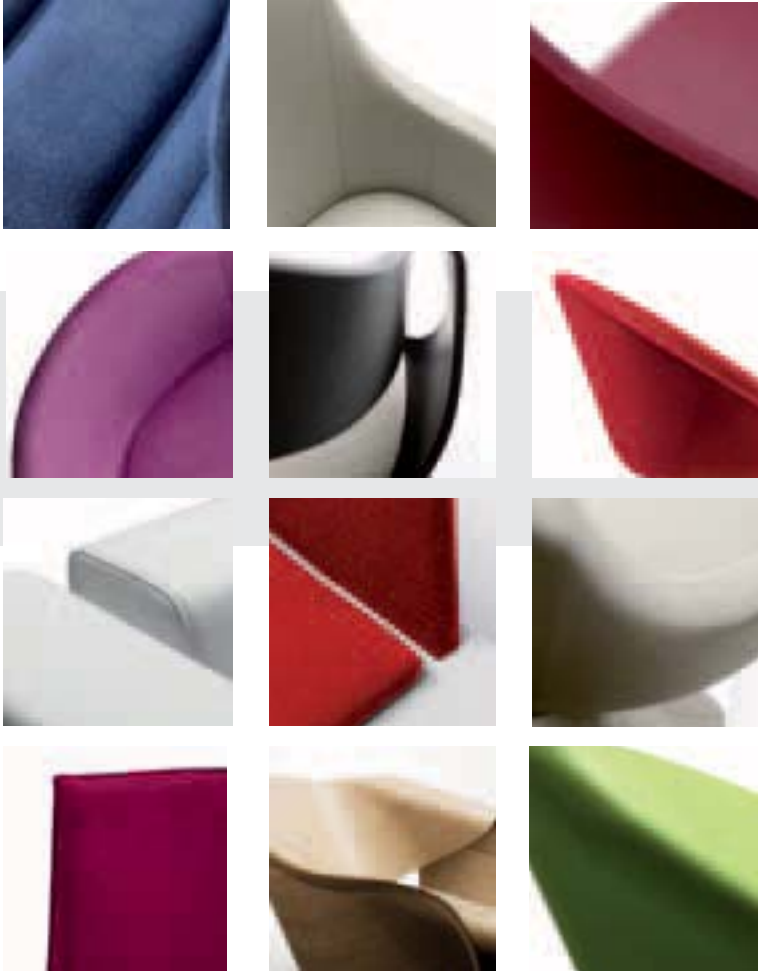

brighten your business

MOVING

Cat.G

LEATHER - PELLE



Pelle bovina
Bovine hide



700 g/m²



BS 5852



UNI EN ISO 105 B02 (5)
UNI EN ISO 11640 (≥4)



Vera Pelle
Genuine Leather



PF03



PF06



PF02



PF11

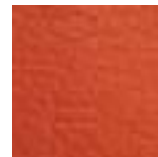

PF13



PF10

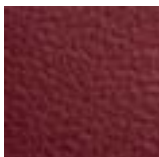

PF05



PF15



PF07

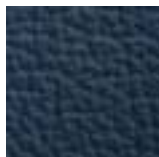

PF04



PF16

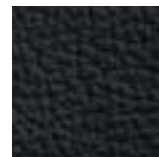

PF08

Cat.G

NEW BLAZER



100% Lana
100% Wool



430 g/m²



BS EN 1021 - 1/2
BS 5852
BS 7176
UNI 9175 Classe 1 IM



BS EN ISO 12947 - 2
50.000 Cicli/Cycles



UNI EN ISO 105 B02 (5)



NB15



NB01



NB13



NB49



NB24



NB02



63 % Poliuretano/Polyurethane
29 % Cotone/Cotton
8 % Poliestere/Polyester



480 g/m²



EN 1021 - 2/93
IMO Resolution A.652(16)/89
BS 5852 - 1/79 part 1
BS 5852/90 - crib 5
UNI 9175 classe 1.IM



UNI EN ISO 12947 - 2
150.000 Cicli/Cycles



UNI EN ISO 105 B02 (5)



ULTRA-FRESH
Antibatterico/Antimicrobial
Antiacaro/Antiacarus

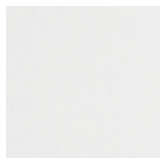

EP01



EP02



EP06



EP03



EP04



EP12



EP07



EP08



EP13



EP09



EP14



EP05



EP10



EP11



EP15

Cat.G

82 % Poliestere/Polyester
18 % Cotone/Cotton

443 g/m²

UNI EN ISO 12947 - 2
30.000 Cicli/Cycles

UNI EN ISO 105 B02 (5)



DU01



DU07



DU08

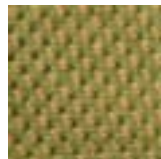

DU05

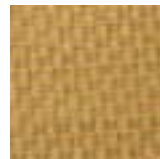

DU13

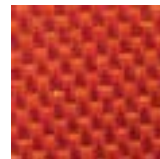

DU02

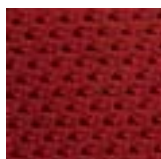

DU03



DU09

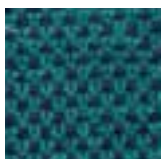

DU12

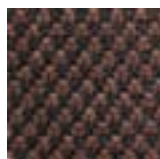

DU10

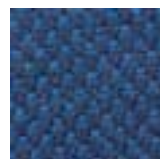

DU11

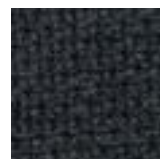

DU06

Cat.F

100% Poliestere/Polyester

457 g/m²

UNI EN ISO 12947 - 2
30.000 Cicli/Cycles

UNI EN ISO 105 B02-94 (5)



AC01



AC07

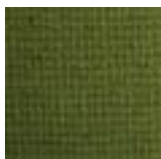

AC04



AC08

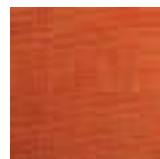

AC06



AC05



AC02

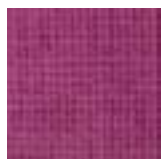

AC03

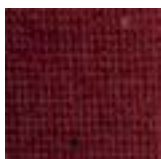

AC09

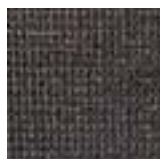

AC10



AC11

DUETTO

ACUTO

Cat.F



100% Poliestere/Polyester



280 g/m²



UNI EN 20344-45
52.000 Cicli/Cycles



AP01



AP02



AP03



AP07

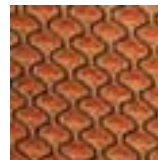

AP05

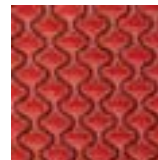

AP06

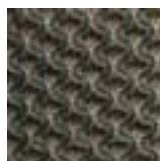

AP04

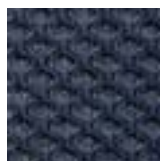

AP08

Cat.F



81 % Poliestere/Polyester
12 % Cotone/Cotton
7 % Acrilico/Acrylic



414 g/m²



UNI EN ISO 12947 - 2
> 20.000 Cicli/Cycles



UNI EN ISO 105 B02 (4/5)



Anti Macchia
Stain-Removing Power



Idrorepellente
Waterproof



RI01



RI07

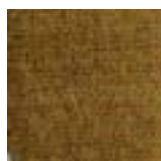

RI11



RI06

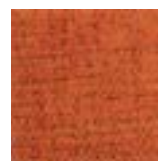

RI12



RI08

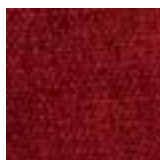

RI04

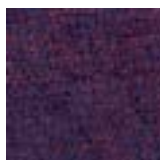

RI09



RI03



RI10

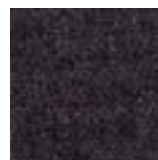

RI02



RI05

ARPA

RITMO



100% Nylon



205 g/m²



UNI EN 20344-45
100.000 Cicli/Cycles



KR03

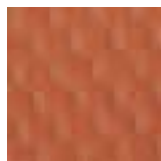

KR06



KR05

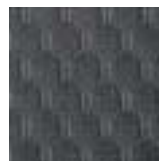

KR04

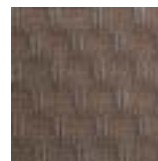

KR01



KR02

Legenda/ Legend



Composizione
Composition



Resistenza all'abrasione
Abrasion Resistance
Martindale



Peso
Weight



Antibatterico/Antimicrobial
Antiacaro/Antiacarus



Infiammabilità
Flame Retardant



Idrorepellente
Waterproof



Solidità Colore
Colour Fastness



Anti Macchia
Stain-Removing Power

Pulizia e Manutenzione/Cleaning and Maintenance

Pulizia ordinaria: spolverare delicatamente il rivestimento con una spazzola morbida. Usare una soluzione leggera di acqua e sapone neutro da applicare delicatamente con un panno inumidito, far asciugare e spazzolare ancora per ravvivare il tessuto.

Periodicamente ammorbidire la pelle con un panno imbevuto di acqua e sapone neutro.

Ordinary cleaning: gently remove upholstery dust with a soft brush. Use a mild solution of neutral soap and water to be applied gently with a dampened cloth. Dry and revive the fabric by brushing again.

Periodically soften the leather by using a cloth dampened with water and neutral soap.

Cat.D

48% Poliuretano/ Polyurethane
31% Cotone/Cotton
21 % Poliestere/Polyester

 450 g/m²

 UNI 9175 Classe 1 IM
BS 5852-1
UNI EN 1021-1

 EN 1.3520 (01)
>100.000 Cicli/Cycles

 UNI EN ISO 105 B02 (5)

SILVIA

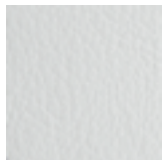

SL01



SL26



SL27



SL24

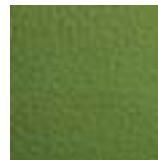

SL23



SL28



SL21



SL29



SL14



SL15



SL20



SL39



SL10

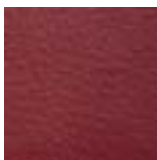

SL11



SL30



SL25



SL17

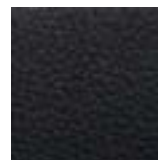

SL05

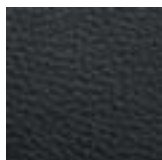

SL18

PAINTING/VERNICIATURE



Rovere sbiancato
Bleached light oak veneered painted



Wengè
Wengè oak veneered painted

MATT LACQUERING/LACCATURE



RAL 9010

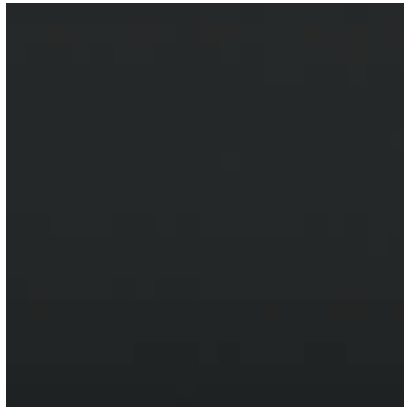

RAL 9005



RAL 3003

Informazioni Importanti

Important Information

Il presente catalogo annulla e sostituisce ogni precedente.

I rivestimenti possono presentare delle lievi differenze di tonalità rispetto ai campioni.

Moving, al fine di migliorare le caratteristiche tecniche e qualitative della sua produzione, si riserva il diritto, in qualsiasi momento, di modificare in tutto o in parte il contenuto del presente catalogo anche senza preavviso.

This catalogue supersedes all previous issues.

Upholsteries might present slight differences in tonality compared to the samples.

Moving, to improve the technical and qualitative characteristics of production, reserves the right at any time to modify entirely or partially the content of the present catalogue even without notice.



MOVING®

Via dell'artigianato, 1 - 36070 Trissino (VI) Italy
Tel. +39 0445 490777 - Fax. +39 0445 490008
info@moving.vi.it - www.moving.vi.it



Certification and guarantee
of absolute product quality



IQNet Certified
Management System



ISO 9001:2000
Quality



ISO 14001:2004
Environmental



OHSAS 18001:2007
Safety



MOVING TECHNOLOGY ITALIAN STYLE

www.moving.vi.it



MOVING[®]