

02 Escolplan

ES| Equipamiento escolar
GB| School equipment
FR| Equipement scolaire
DE| Schulinrichtungen
IT| Equipaggiamento scolastico
PO| Equipamiento escolar

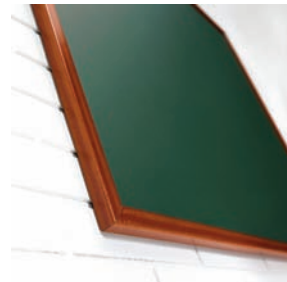

es| Equipamiento escolar
La familia escolar por excelencia. ESCOLPLAN, mantiene una sinergia clara con Visualplan. La tiza como herramienta de escritura y el color verde, son su principal diferencia. El amplio sector escolar, desde escuelas infantiles, de educación primaria y secundaria, así como universidades y escuelas de negocios, son los principales tipos de mercado de ésta gama de producto. El sector de la hostelería también centra especial atención a la pizarra tradicional de tiza.

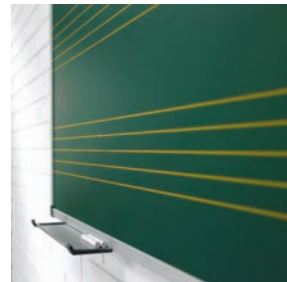

FR| Equipement scolaire
Cette famille de produit a une large gamme adaptée pour la formation en général. Des tableaux verts de tous types et de différentes qualités pour satisfaire tous les utilisateurs qu'ils soient scolaire, professionnels, universitaires... Les salles de formation, le bureau, les salles de réunion, universités, les écoles et l'hôtellerie sont les principaux objectifs de cette famille de produit.

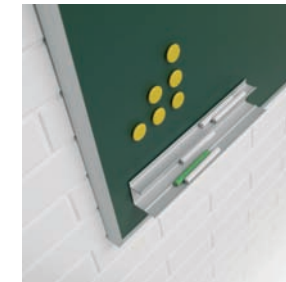

IT| Equipaggiamento scolastico
Il prodotto scolastico per eccellenza. ESCOLPLAN mantiene una chiara sinergia con la famiglia del VISUAL plan. La principale differenza fra le lavagne da gesso e quelle per pennarelli è che le prime sono verdi. Sono dirette all'intero segmento scolastico dagli asili, alle scuole medie e licei ed università.



GB| School equipment
This family product has a broad range of items focused to the educational segment. It is composed of different types and qualities of Green/black boards to meet all kind of teaching areas as schools universities, sales training, offices, meeting rooms, hotels, restaurants are the main targets of this family product who are used to the traditional chalk.

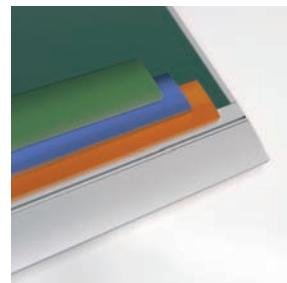

DE| Schulinrichtungen
Die unumstrittene Schulfamilie. ESCOLPLAN und VISUALPLAN werden offenbar durch Synergien vereinigt. Kreide als das Schreiben-Instrument und die grüne Farbe sind die Hauptunterschiede. Die ganzen Schulsektor, die Haupt- und Gesamtschulen, die Universitäten und die Wirtschaftsschulen sind die Hauptmarktmittel dieses Produktangebots. Hotelgeschäft wird auch hauptsächlich auf die traditionelle Kreidetafeln gerichtet.



PO| Equipamiento escolar
A família escolar por excelência. ESCOLPLAN, mantém uma sinergia clara com a família Visualplan. O giz como ferramenta de escrita e a cor verde, são a sua principal diferença. O amplo sector escolar, desde escolas infantis, de educação primária e secundária, assim como universidades e escolas de negócios, são os principais tipos de mercado desta gama de produtos. O sector da hotelaria também centra especial atenção no quadro tradicional de giz.



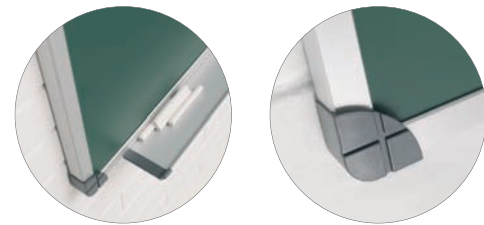

A
rail

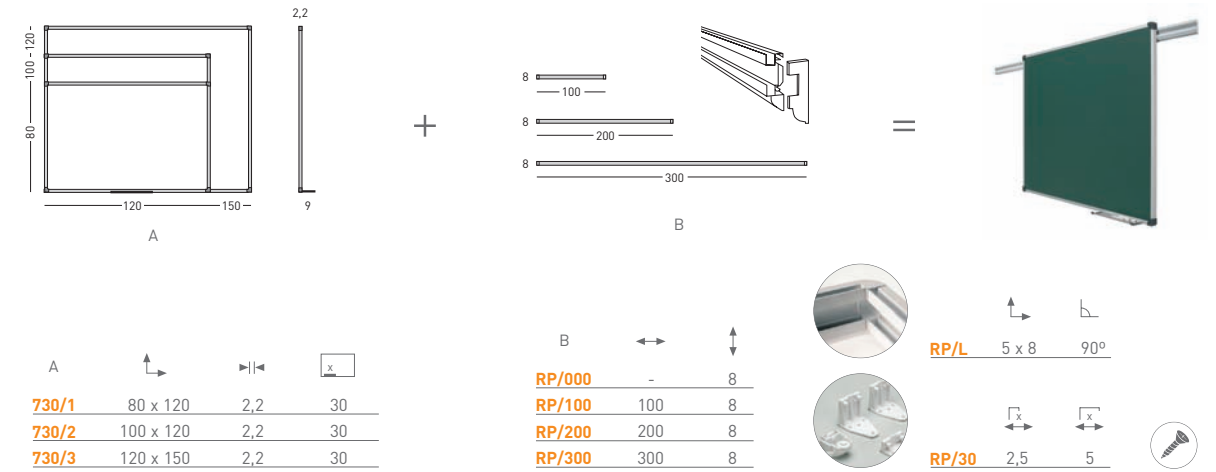

pg. 36-37

B
T

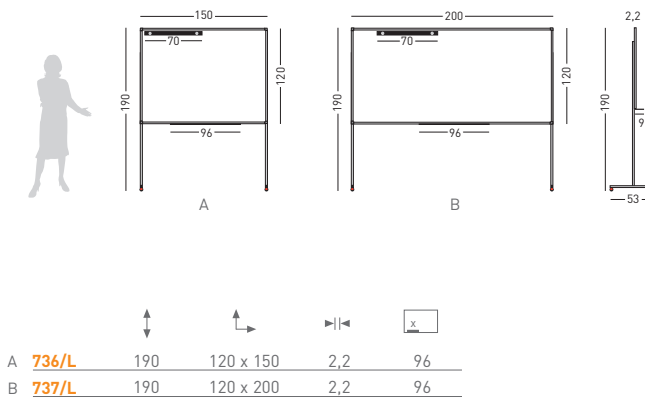

pg. 34



C
delta

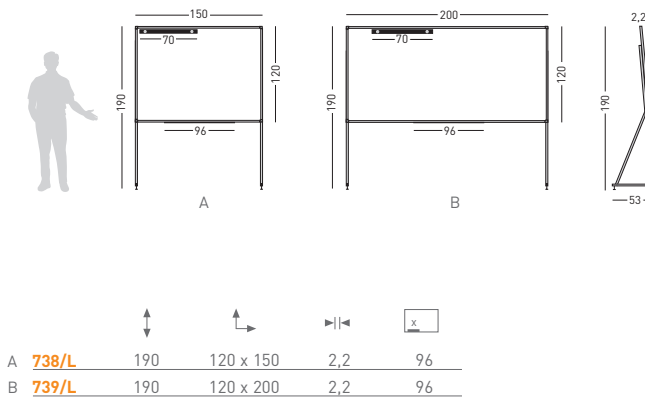

pg. 35



ES | Pizarra mural verde laminada

Pizarra mural verde enmarcada con perfil de aluminio anodizado en color plata mate y cantoneras redondeadas de plástico gris. Superficie laminada para escritura con tiza. Incluye cajetín reposarrotuladores de 30 cm.

FR | Tableau vert stratifié

Tableau vert avec encadrement aluminium anodisé argent et coins arrondis en plastic. Surface laminé pour écriture à la craie. Livré avec auget porte-marqueurs 30 cm.

IT | Lavagna laminata

Lavagna con cornice in alluminio anodizzato ed angoli grigi in plastica arrotondati. Superficie laminata. Include porta gessi di 30 cm.

GB | Laminated chalk board

Chalk board equipped with silver anodised aluminium frame and plastic rounded corners. Laminated surface. A 30 cm. pen tray included.

DE | Laminierte Kreidetafel

Kreidetafel mit anodisiertem Aluminiumrahmen, silber eloxiert und abgerundeten grauen Kunststoffecken. Laminierte Schreiftafeloberfläche mit kreide beschreibbar. Lieferung inkl.: Stiftablage 30 cm. lang.

PO | Quadro de parede verde laminado

Quadro de parede verde com perfil de alumínio anodizado na cor prata mate e cantos arredondados em plástico cinzento. Superfície laminada para escrita com giz. Inclui suporte para giz com 30 cm.

X
acces

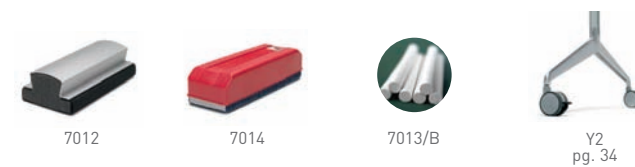

pg. 87

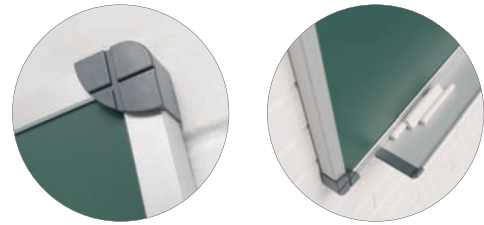

	↑	→	x
730/A1	120 x 100	2,2	30
730/A2	120 x 150	2,2	30
730/A3	120 x 200	2,2	30
730/A4	120 x 250	2,2	30
730/A5	120 x 300	2,2	30
730/A6	120 x 400	2,2	30

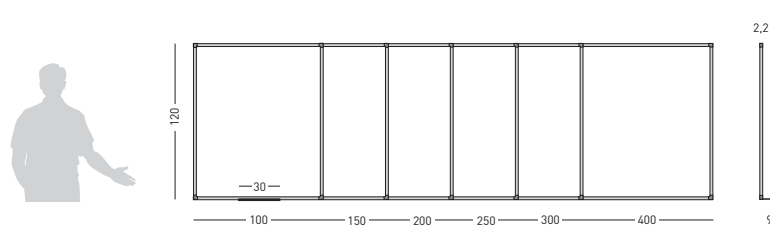

ES | Pizarra mural verde de acero vitrificado
Pizarra mural verde enmarcada con perfil de aluminio anodizado en color plata mate y cantoneras redondeadas de plástico gris. Superficie magnética de acero vitrificado a 800 °C para escritura con tiza. Incluye cajetín de 30 cm. Fabricadas en una pieza.

GB | Enamelled chalk board
Chalk board equipped with silver anodised aluminium frame and plastic rounded corners. Magnetic 800°C enamelled steel surface, green for chalk. A 30 cm. pen tray is included. Manufactured in one piece.

FR | Tableau émaillé vert
Tableau vert en acier émaillé à 800 °C avec encadrement aluminium anodisé couleur argent et coins arrondis en plastic. Surface magnétique émaillée vitrifiée à 800° C pour écriture à la craie. Livré avec auget porte-marqueurs de 30 cm. Fabriqué d'une pièce.

DE | Emailierte Kreidetafel
Kreidetafel mit anodisiertem Aluminiumrahmen, silber eloxiert und abgerundeten grauen Kunststoffecken. Magnethaftend emailierte Schreiftafeloberfläche, eingebrannt bei 800° C, mit Kreide beschreibbar. Lieferung inkl. Stiftablage 30 cm. lang.

IT | Lavagna smaltata
Lavagna smaltata con cornice in alluminio anodizzato ed angoli grigi in plastica arrotondati. Superficie magnetica in acciaio smaltato ad 800° per scrittura con gesso. Include porta gessi di 30 cm., fabbricata una alla volta.

PO | Quadro de parede verde aço vitrificado
Quadro de parede verde com perfil de alumínio anodizado na cor prata mate e cantos arredondados em plástico cinzento. Superfície magnética de aço vitrificado a 800° C para escrita com giz. Inclui suporte para giz com 30 cm. Fabricada numa peça.

A
rail

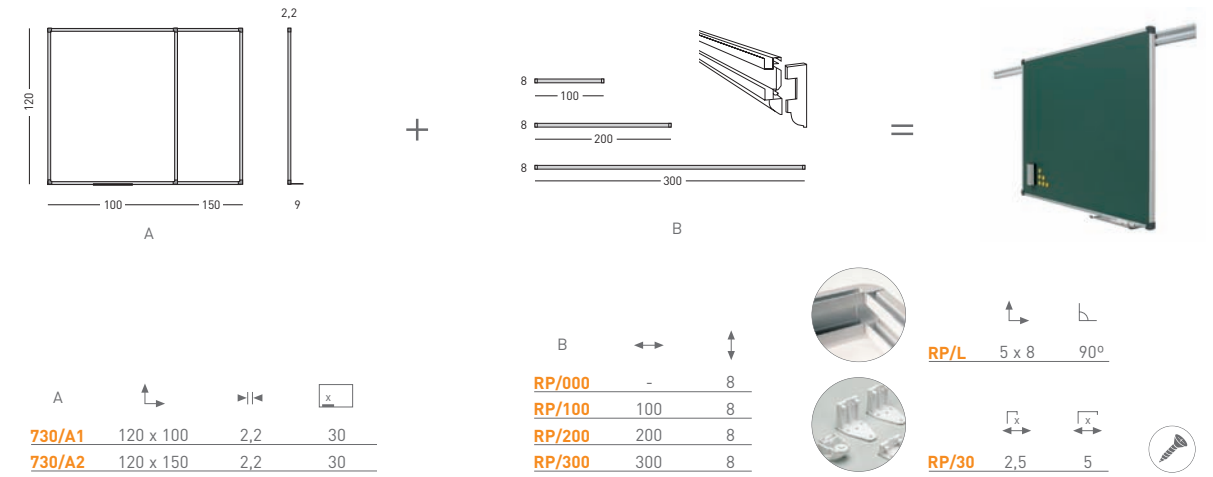

pg. 36-37

A	↑	→	x
730/A1	120 x 100	2,2	30
730/A2	120 x 150	2,2	30

B	↔	↑
RP/000	-	8
RP/100	100	8
RP/200	200	8
RP/300	300	8

RP/L 5 x 8 90°

RP/30 2,5 5



B
T

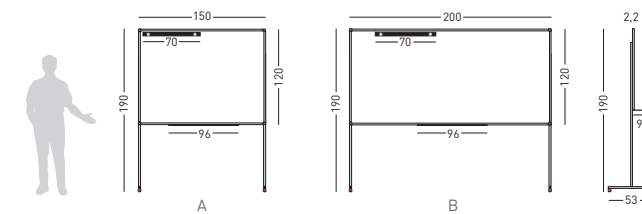

pg. 34

A	↑	→	x
736/A	190	120 x 150	2,2 96
737/A	190	120 x 200	2,2 96



C
delta

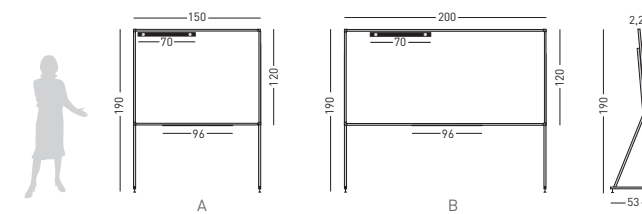

pg. 35

A	↑	→	x
738/A	190	120 x 150	2,2 96
739/A	190	120 x 200	2,2 96



X
acces

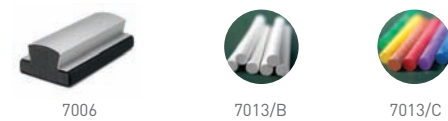

pg. 87

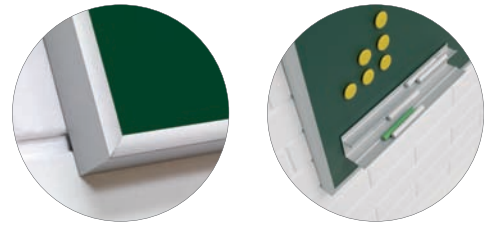

	↕	↔	⊠
734/10	40 x 60	2,3	30
734/1	60 x 80	2,3	30
734/2	80 x 100	2,3	30
734/3	100 x 120	2,3	30
734/4	120 x 150	2,3	30
734/5	120 x 200	2,3	30
734/6	120 x 250	2,3	30

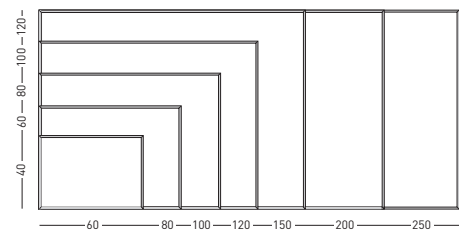

ES | Pizarra verde acero vitrificado marco "mini"
Pizarra mural verde enmarcada con perfil de aluminio anodizado en color plata mate marco mini a inglete. Superficie magnética de acero vitrificado a 700° C con garantía de por vida. Incluye cajetín reposatizas.

FR | Tableau vert en acier émaillé "mini"
Tableau vert en acier émaillé avec cadre "mini" en aluminium anodisé à angles droits. Surface magnétique vitrifiée, cuite à 700°C. Garantie à vie. Livré avec auget porte-marqueurs.

IT | Lavagna verde acciaio vitrificato "mini"
Lavagna verde da parete con cornice in alluminio anodizzato colore argento opaco, spessore cornice mini e ad angolo acuto. Superficie magnetica in acciaio vitrificato a 700° C, con garanzia a vita. Include cofanetto portaccessori.

GB | Chalkboard in enamelled steel "mini"
Enamelled steel chalkboard with anodized aluminium "mini" mitred frame. Magnetic surface cooked at 700°C, lifetime guaranteed. Delivered with marker-holder.

DE | Emailierte "mini" Kreidewandtafel
Emailierte mini Kreidewandtafel mit anodisierten Aluminiumrahmen, mattsilber eloxiert mit abgerundeten grauen Kunststoffecken. 700°C magnethaftende emailierte Schreiboberfläche. Lebenslanger Garantie. Lieferung mit Stiftablage.

PO | Quadro verde em aço vitrificado "mini"
Quadro de parede verde com perfil mini, sem cantos, em alumínio anodizado na cor prata mate. Superfície magnética em aço vitrificado a 700° C com garantia vitalícia. Inclui suporte para giz.

A
rail

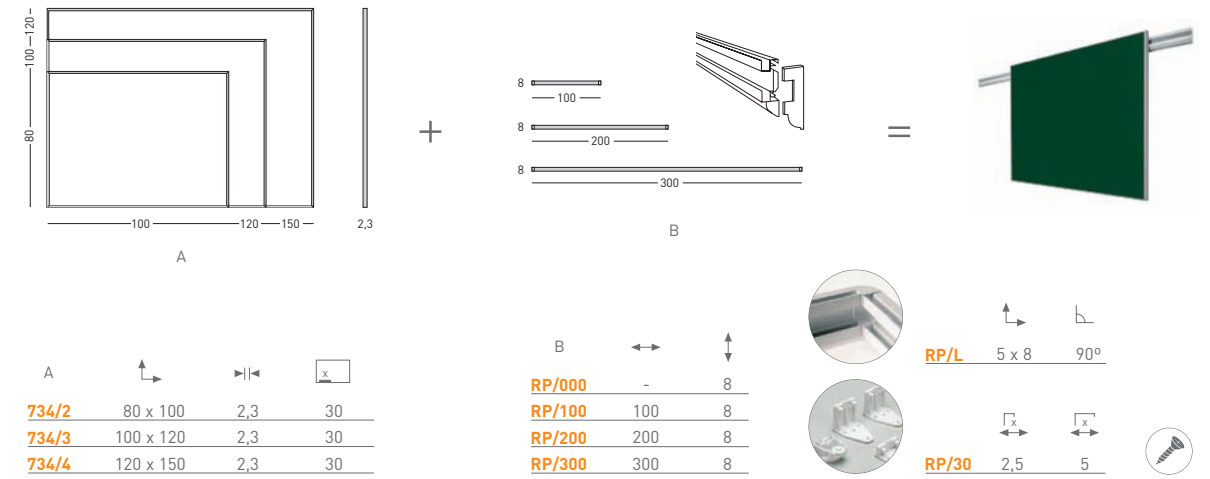

pg. 36-37

A	↕	↔	⊠
734/2	80 x 100	2,3	30
734/3	100 x 120	2,3	30
734/4	120 x 150	2,3	30

B	↕	↔
RP/000	-	8
RP/100	100	8
RP/200	200	8
RP/300	300	8

RP/L	↕	↔
5 x 8	90°	
RP/30	2,5	5

B
T

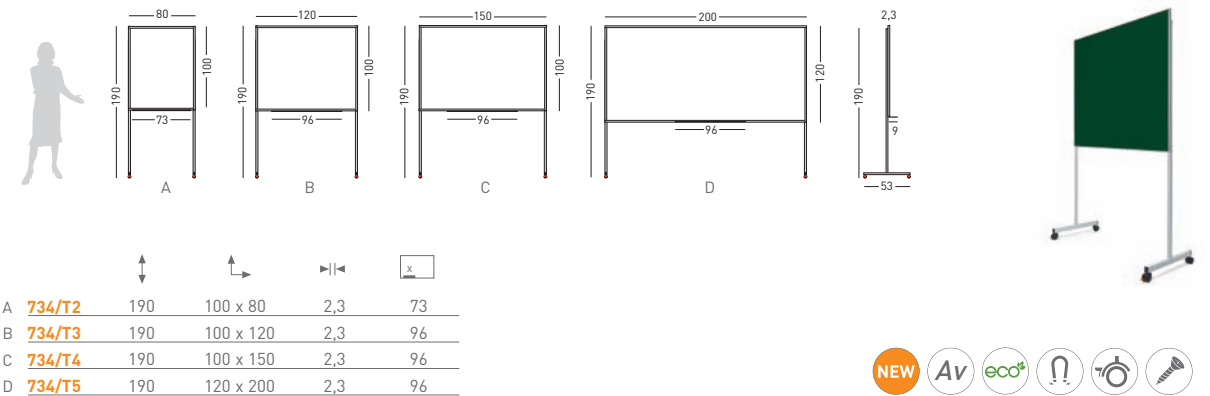

pg. 34

	↕	↔	⊠
A 734/T2	190	100 x 80	2,3 73
B 734/T3	190	100 x 120	2,3 96
C 734/T4	190	100 x 150	2,3 96
D 734/T5	190	120 x 200	2,3 96



C
delta

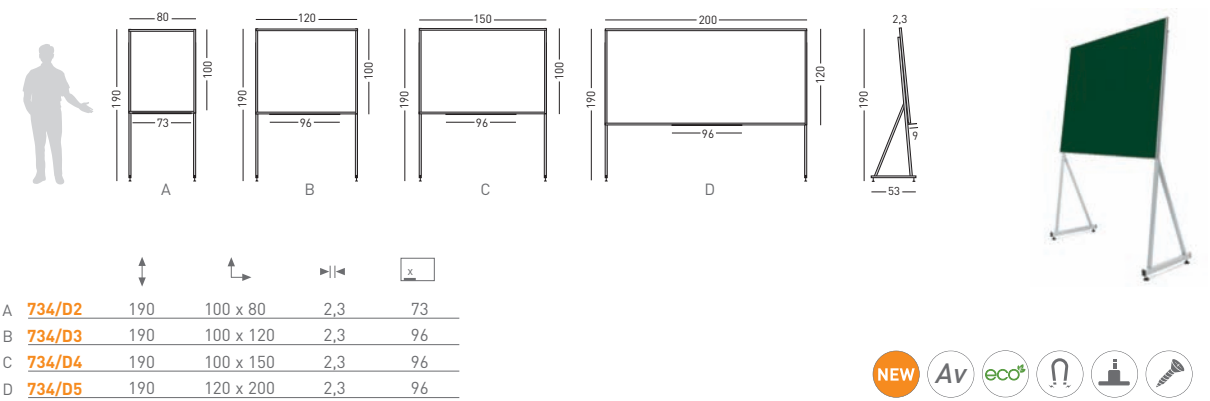

pg. 35

	↕	↔	⊠
A 734/D2	190	100 x 80	2,3 73
B 734/D3	190	100 x 120	2,3 96
C 734/D4	190	100 x 150	2,3 96
D 734/D5	190	120 x 200	2,3 96



X
acces

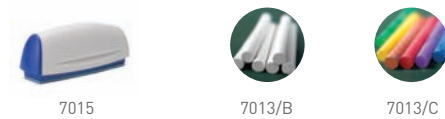

pg. 87

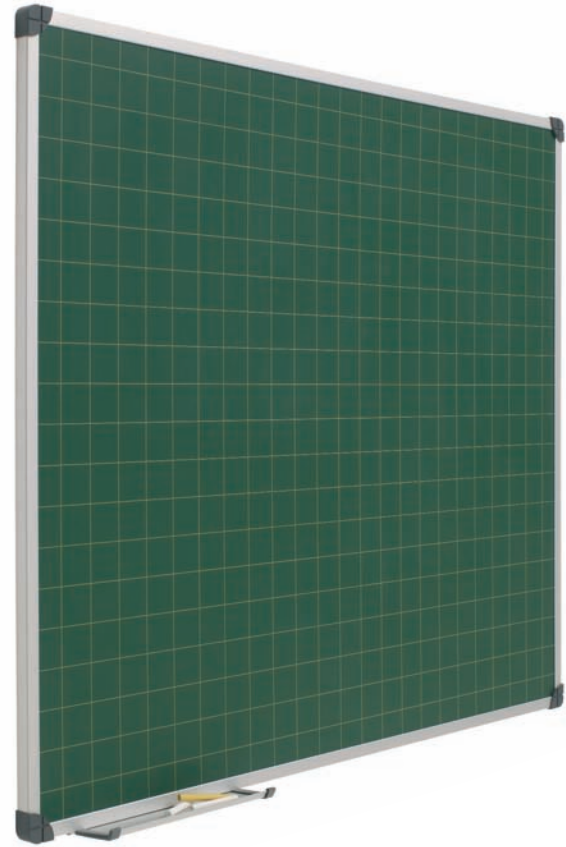
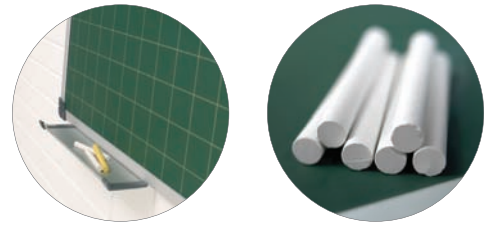

A		B	
↑	→	↑	→
120	120	120	120
150	150	150	150
200	200	200	200
300	300	300	300
2,2	2,2	2,2	2,2
30	30	30	30

A		B	
↑	→	↑	→
100	120	100	120
120	150	120	150
120	200	120	200
120	300	120	300
2,2	2,2	2,2	2,2
30	30	30	30

A		B	
↑	→	↑	→
100	120	100	120
120	150	120	150
120	200	120	200
120	300	120	300
2,2	2,2	2,2	2,2
30	30	30	30

ES | Pizarra mural verde cuadrículada
Pizarra mural verde cuadrículada enmarcada con perfil de aluminio anodizado en color plata mate y cantoneras redondeadas de plástico gris. Superficie para escritura con tiza. Incluye cajetín reposarrotuladores de 30 cm.

FR | Tableau quadrillé vert
Tableau quadrillé vert avec encadrement aluminium anodisé couleur argent et coins arrondis en plastic. Surface pour écriture à la craie. Livré avec auget porte-marqueurs 30 cm.

IT | Lavagna a griglia
Lavagna a griglia con cornice in alluminio anodizzato ed angoli arrotondati in plastica grigia. Porta penne cm. 30 incluso.

GB | Grided chalk board
Grided chalk board equipped with silver anodised aluminium frame and plastic rounded corners. A 30 cm. pen tray included.

DE | Rasterkreidetafel
Rasterkreidetafel mit anodisiertem Aluminiumrahmen, silber eloxiert und abgerundeten grauen Kunststoffecken. Schreibtafeloberfläche mit Kreide beschreibbar. Lieferung inkl.: Stiftablage 30 cm. lang.

PO | Quadro verde quadriculado
Quadro de parede verde quadriculado com perfil de alumínio anodizado na cor prata mate e cantos arredondados em plástico cinzento. Superfície para escrita com giz. Inclui suporte para giz com 30 cm.

A
rail

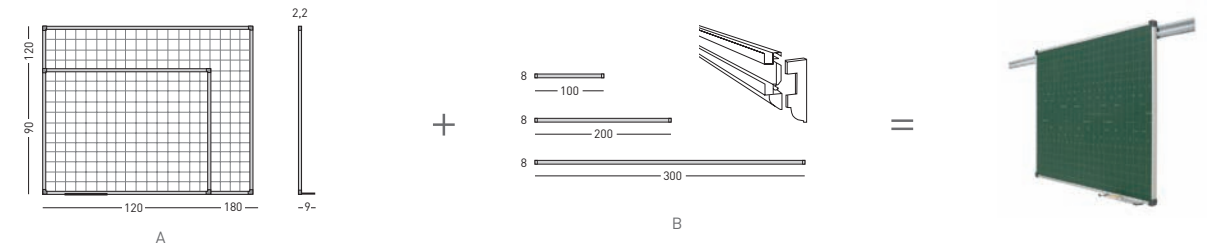

A	↑	→	→	→
730/A/C1	100	120	2,2	30
730/A/C2	120	150	2,2	30
730/C1	100	120	2,2	30
730/C2	120	150	2,2	30

B	↑	→	→	→
RP/000	-	8		
RP/100	100	8		
RP/200	200	8		
RP/300	300	8		

RP/L	↑	→	→	→
5 x 8	90°			
RP/30	2,5	5		

pg. 36-37

B
T

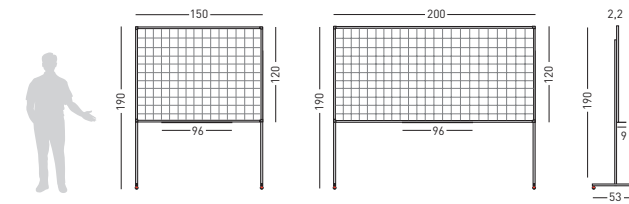

A	↑	→	→	→
730/AC/T2	190	120 x 150	2,2	
730/AC/T3	190	120 x 200	2,2	

B	↑	→	→	→
730/C/T2	190	100 x 150	2,2	
730/C/T3	190	120 x 200	2,2	



pg. 34

C
delta

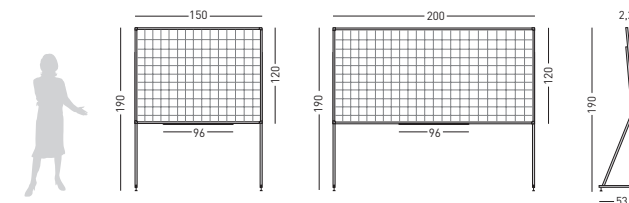

A	↑	→	→	→
730/AC/D2	190	120 x 150	2,2	
730/AC/D3	190	120 x 200	2,2	

B	↑	→	→	→
730/C/D2	190	120 x 150	2,2	
730/C/D3	190	120 x 200	2,2	



pg. 35

X
acces



pg. 87

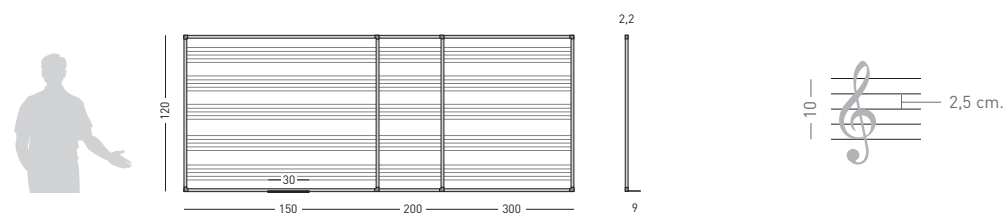
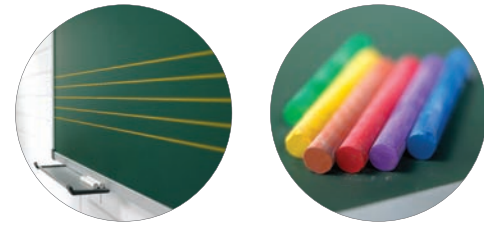

A	↑	→	⊗
730/A/P1	120 x 150	2,2	30
730/A/P2	120 x 200	2,2	30
730/A/P3	120 x 300	2,2	30

B	↑	→	⊗
730/P1	120 x 150	2,2	30
730/P2	120 x 200	2,2	30
730/P3	120 x 300	2,2	30

es | Pizarra mural verde con pentagrama
Pizarra verde con pentagrama enmarcada con perfil de aluminio anodizado en color plata mate y cantoneras redondeadas de plástico gris. Superficie para escritura con tiza. Incluye cajetín reposarrotuladores de 30 cm. 5 pentagramas en color amarillo.

fr | Tableau pentagramme vert
Tableau pentagramme vert avec encadrement aluminium anodisé couleur argent et coins arrondis en plastic. Surface pour écriture à la craie. Livré avec auget porte-marqueurs 30 cm. 5 pentagrammes de couleur jaune.

it | Lavagna a pentagramma
Lavagna a pentagramma con cornice in alluminio anodizzato ed angoli arrotondati in plastica grigia. Porta penne cm. 30 incluso. 5 righe di pentagramma gialle.

68 | Pentagram chalk board
Pentagram chalk board equipped with silver anodised aluminium frame and plastic rounded corners. A 30 cm. pen tray included. 5 yellow pentagrams.

de | Pentagrammkreidetafel
Pentagrammkreidetafel mit anodisiertem Aluminiumrahmen, silber eloxiert und runden grauen Kunststoffecken. Oberfläche mit Kreide beschreibbar. Lieferung inkl. Stiftablage 30 cm. lang. 5 gelbe Pentagramme.

pt | Quadro verde pautado
Quadro de parede verde, pautado com perfil de alumínio anodizado na cor prata mate e cantos arredondados em plástico cinzento. Superfície para escrita com giz. Inclui suporte para giz com 30 cm. Tem 5 linhas na cor amarela.

A
rail

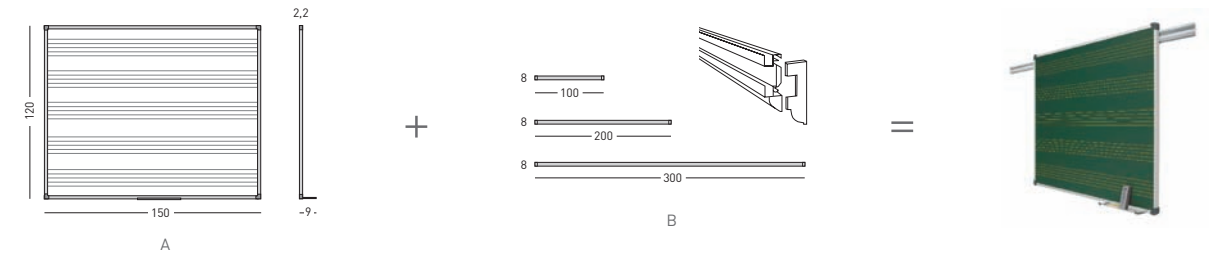

A	↑	→	⊗
730/A/P1	120 x 150	2,2	30
730/P1	120 x 150	2,2	30

B	↑	→	⊗
RP/000	-	8	
RP/100	100	8	
RP/200	200	8	
RP/300	300	8	



pg. 36-37

B
T

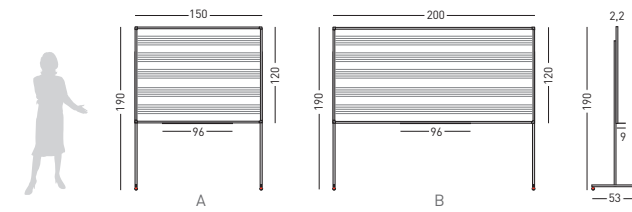

A	↑	→	⊗
736/A/P2	190	120 x 150	2,2
737/A/P3	190	120 x 200	2,2

B	↑	→	⊗
736/L/P2	190	120 x 150	2,2
737/L/P3	190	120 x 200	2,2



pg. 34

C
delta

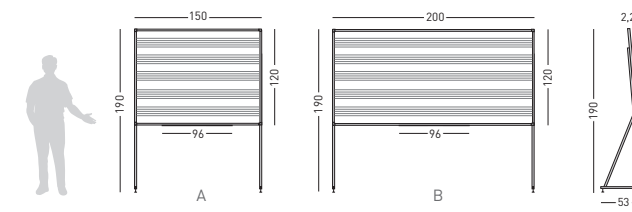

A	↑	→	⊗
738/A/P2	190	120 x 150	2,2
739/A/P3	190	120 x 200	2,2

B	↑	→	⊗
738/L/P2	190	120 x 150	2,2
739/L/P3	190	120 x 200	2,2



pg. 35

X
acces

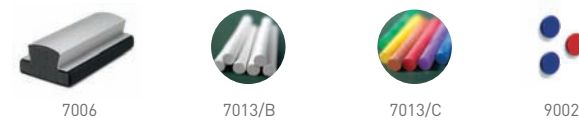

pg. 87

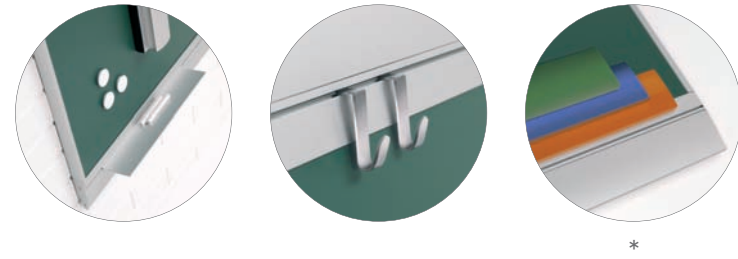

A
rail

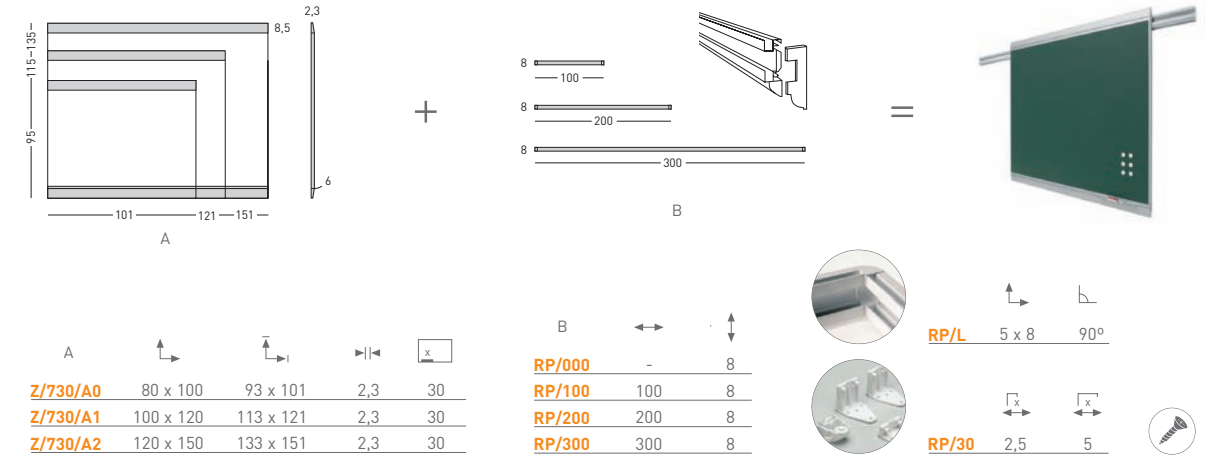

pg. 36-37

B
Y2

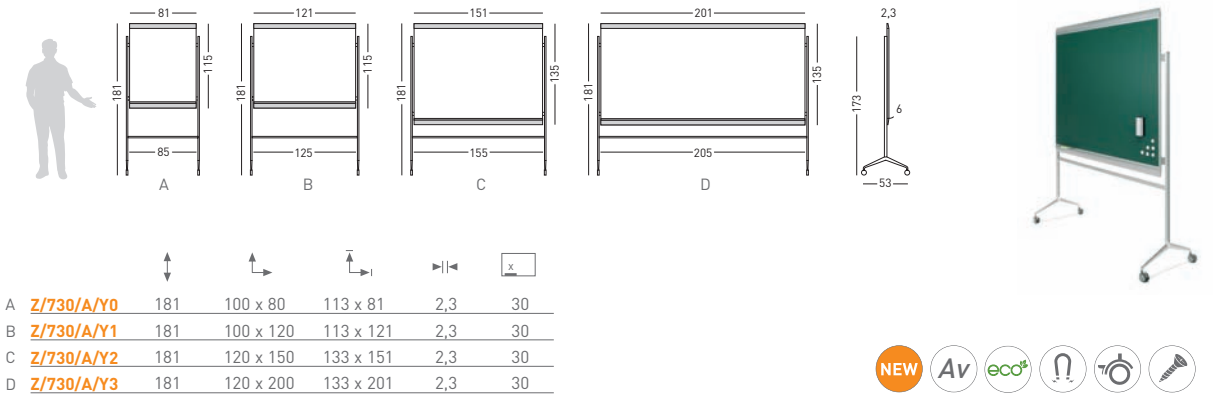

pg. 34



*A	60 x 80	73 x 81	2,3	30
Z/730/A0	60 x 80	73 x 81	2,3	30
Z/730/A1	80 x 100	93 x 101	2,3	30
Z/730/A2	100 x 120	113 x 121	2,3	30
Z/730/A3	100 x 150	113 x 151	2,3	30
Z/730/A4	100 x 175	113 x 176	2,3	30
Z/730/A5	120 x 200	133 x 201	2,3	30
Z/730/A6	120 x 250	133 x 251	2,3	30

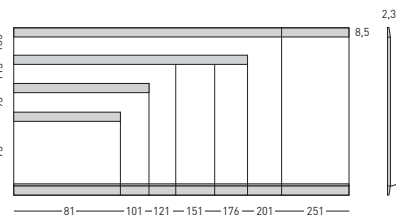

*B	80 x 120	93 x 121	2,3	30
Z/730/A0	80 x 120	93 x 121	2,3	30
Z/730/A1	100 x 150	113 x 151	2,3	30
Z/730/A2	120 x 150	133 x 151	2,3	30
Z/730/A3	120 x 200	133 x 201	2,3	30
Z/730/A4	120 x 250	133 x 251	2,3	30
Z/730/A5	120 x 300	133 x 301	2,3	30

C
/C - /P

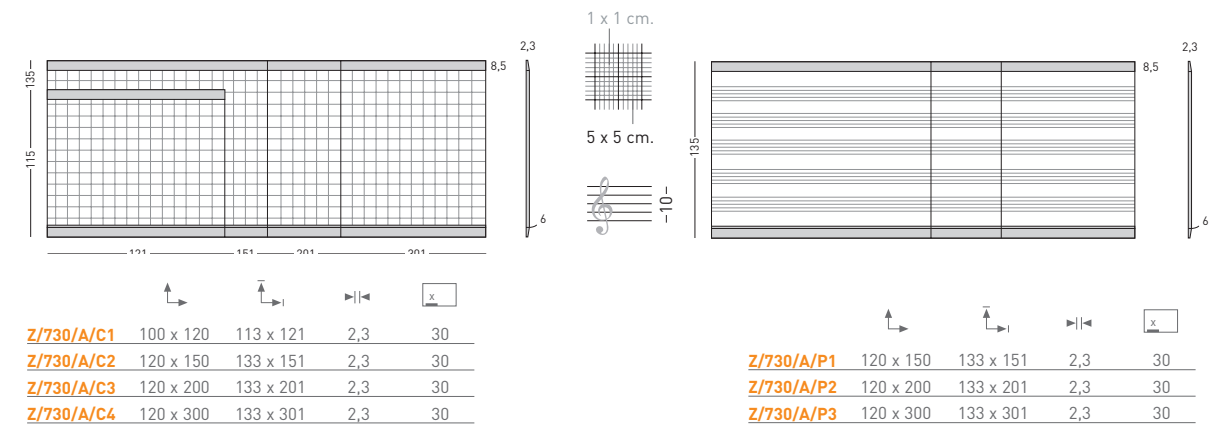

ES | Pizarra verde "Zénit" de acero vitrificado
Pizarra verde Zénit enmarcada con perfil de aluminio anodizado en color plata (tapa personalizable). Superficie laminada verde brillo. Incluye bandeja reposatizas.

FR | Tableau vert "Zénit" stratifié
Tableau Zénit vert avec cadre en aluminium anodisé couleur argent (carters personnalisables). Surface verte stratifié et brillante. Inclus un auget pour les craies.

IT | Lavagna verde "Zénit" acciaio Vitrificato
Lavagna verde Zenit con cornice in alluminio anodizzato colore argento opaco (personalizzabile). Superficie magnetica in acciaio vitrificato a 700° C, con garanzia a vita. Include cofanetto portaccessori. Colore: verde, azzurro, nero, grigio.

GB | Chalkboard "Zénit" in enamelled steel
Vitrified chalkboard cooked at 700° C with anodized aluminium frame (customizable). Lifetime guaranteed, magnetic surface for chalk writing. Delivered with a 30 cm marker-holder. Colour green, blue, black or grey.

DE | Grüne Tafel "Zénit"
Grüne Wandtafel "Zénit", mit einem mattsilbernen, anodisiertem Aluminiumrahmen (individuelle Abdeckung), grün glänzend beschichtete Oberfläche geeignet für Trockenbeschriftung, Kreideablageschale

PO | Quadro verde "Zénit" em Aço Vitrificado
Quadro verde Zénit, com perfil em alumínio anodizado na cor prata mate (tampas personalizáveis). Superfície magnética em aço vitrificado a 700° C com garantia vitalícia. Permite a escrita com giz.

X
acces

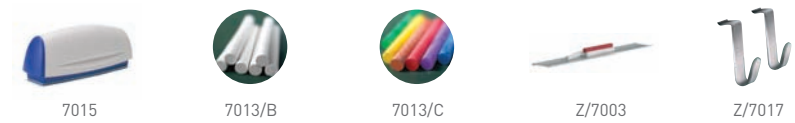

pg. 87

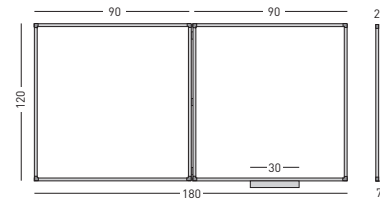
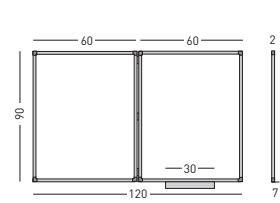
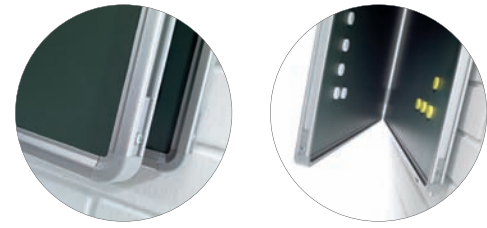

730/D1 90 x 120 90 x 60 2+2 30

730/D2 120 x 180 120 x 90 2+2 30

ES | Pizarra mural verde díptica

Pizarra mural díptica verde de acero vitrificado enmarcada con perfil de aluminio anodizado en color plata mate y cantoneras redondeadas de plástico gris. Posee 3 superficies de escritura con tiza. Incluye cajetín reposarrotuladores de 30 cm.

FR | Tableau diptyque vert

Tableau diptyque vert en acier émaillé avec encadrement en aluminium anodisé couleur argent et coins arrondis en plastic. Panneau double pour écriture à la craie sur les 3 surfaces. Livré avec un auget porte-marqueurs de 30 cm.

IT | Lavagna a doppio pannello

Lavagna smaltata 2 pannelli con cornice in alluminio anodizzato ed angoli arrotondati grigi in plastica. Il doppio pannello permette di avere 3 superfici scrivibili. Porta pannelli da 30 cm. incluso.

GB | Double panelled chalk board

Double panelled chalk board enamelled steel surface equipped with silver anodised aluminium frame and plastic rounded corners. The double panel allows for 3 separate writing surfaces. A 30 cm. pen tray is included.

DE | Klapptafel, Zweiseitig

Kreidewandtafel mit anodisiertem Aluminiumrahmen, Magnethaftend emailierte Schreibtafeloberfläche, silber eloxiert und abgerundeten grauen Kunststoffecken. Die drei hochwertigen Kreidewandtafel Oberfläche sind mit Kreide beschreibbar. Stiftablage 30 cm. long.

PO | Quadro diptico verde

Quadro de parede diptico verde de superfície magnética de aço vitrificado com perfil de alumínio anodizado na cor prata mate e cantos arredondados em plástico cinzento. Possui 3 superfícies de escrita com giz. Inclui suporte para marcadores com 30 cm.

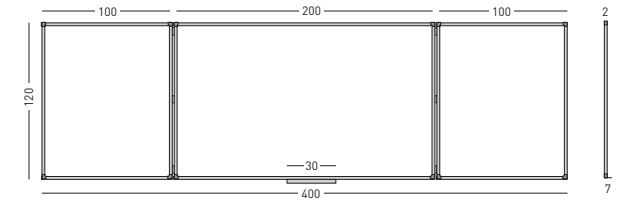
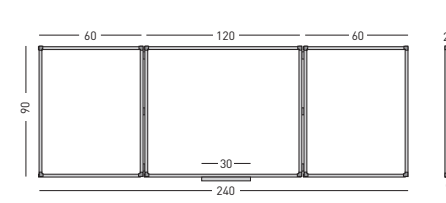
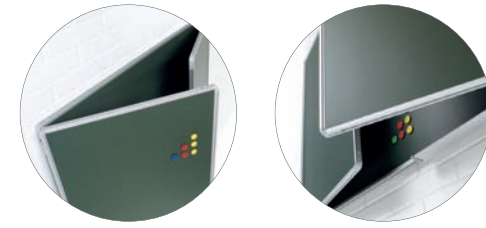

730/T1 90 x 240 90 x 120 2+4 30

730/T2 120 x 400 120 x 200 2+4 30

ES | Pizarra mural verde tríptica

Pizarra mural tríptica verde de acero vitrificado enmarcada con perfil de aluminio anodizado en color plata mate y cantoneras redondeadas de plástico gris. Posee 5 superficies de escritura con tiza. Incluye cajetín reposarrotuladores de 30 cm.

FR | Tableau tryptique vert

Tableau triptyque vert en acier émaillé avec encadrement en aluminium anodisé couleur argent et coins arrondis en plastic. Panneau triple pour écriture à la craie sur les 5 surfaces. Livré avec un auget porte-marqueurs de 30 cm.

IT | Lavagna a tripla pannello

Lavagna smaltata 3 pannelli con cornice in alluminio anodizzato ed angoli arrotondati grigi in plastica. Il triplo pannello permette di avere 5 superfici scrivibili. Porta pannelli da 30 cm. incluso.

GB | Triple panelled chalk board

Triple panelled chalk board enamelled steel surface equipped with silver anodised aluminium frame and plastic rounded corners. The triple panel allows for 5 separate writing surfaces. A 30 cm. pen tray is included.

DE | Klapptafel, Dreiseitig

Flugeltafel mit anodisiertem Aluminiumrahmen, Magnethaftend emailierte Schreibtafeloberfläche, silber eloxiert und abgerundeten grauen Kunststoffecken. Die fünf hochwertigen Kreidewandtafel Oberfläche sind mit Kreide beschreibbar. Stiftablage 30 cm. long.

PO | Quadro triptico verde

Quadro de parede triptico verde de superfície magnética de aço vitrificado com perfil de alumínio anodizado na cor prata mate e cantos arredondados em plástico cinzento. Possui 5 superfícies de escrita com giz. Inclui suporte para marcadores com 30 cm.



	↑ ↓	↕	↔	⊥
730/2/VV1	265	120 x 200	12	
730/2/VV2	265	120 x 250	12	
730/2/VV3	265	120 x 300	12	
730/2/VV4	265	120 x 400	12	

* Consultar medidas especiales.
* Ask us for special sizes.

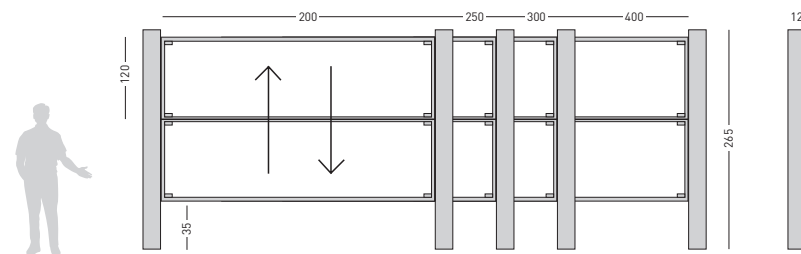

ES | Pizarra de vaivén

Conjunto de 2 pizarras verdes/blancas de acero vitrificado sobre una estructura de aluminio anodizado en plata mate montadas sobre suelo y pared. Las pizarras son independientes entre sí, guiadas por rodamientos de nylon.

GB | 'Vaivén' board

2 enamelled chalk boards/white boards mounted upon a supporting structure in silver anodised aluminium on stand or wall fixation. Both writing surfaces slide vertically and are interdependent of each other. Guidance by nylon castors.

FR | Tableau 'va et viens'

2 tableaux verts ou blancs émaillés montés sur une structure en aluminium anodisé couleur argent sur piètement ou fixation murale. Les deux surfaces se déplacent de façon indépendantes et sont guidées par des poulies en nylon.

DE | Hin und her 'Vaivén' Tafeln

2 emailierte Tafelflächen (weiß oder grün für Kreide) auf zwei Pfosten aus silber eloxiertem Aluminium montiert. Wand- oder Bodenbefestigung. Beide Tafeln sind voneinander unabhängig. Führung über Nylonkettrollen - Kettentrieb.

IT | Doppia lavagna 'vaivén' smaltata

2 lavagne smaltate (verde o bianca) montate su un supporto in alluminio silver fissato a terra o a muro; entrambe le superfici scorrono verticalmente e sono indipendenti l'una dall'altra; la guida avviene mediante ruote in nylon.

PO | Quadro verde de 'vaivén' duplo

Conjunto de 2 quadros verdes/brancos em aço vitrificado sobre uma estrutura de alumínio anodizado na cor prata mate, montada no chão e à parede. O quadro desliza e é guiado num perfil por um sistema de transmissão por cabos e rolamentos de nylon.



	↑ ↓	↕	↔	⊥
730/A1/G1	265	120 x 200	12	
730/A1/G2	265	120 x 250	12	
730/A1/G3	265	120 x 300	12	
730/A1/G4	265	120 x 400	12	

* Consultar medidas especiales.
* Ask us for special sizes.

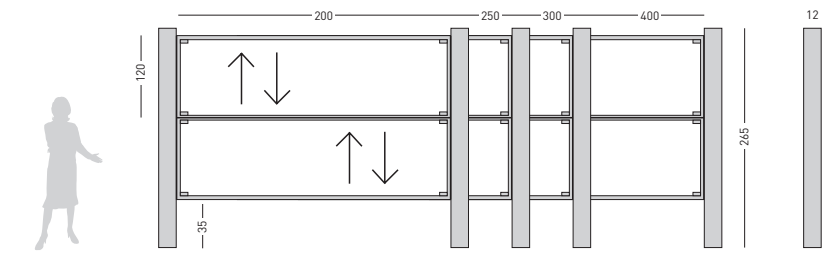

ES | Pizarra de guillotina

Pizarra verde/blanca de Acero vitrificado sobre una estructura de aluminio anodizado en plata mate montada sobre suelo y pared. La pizarra se desliza y va guiada en el perfil por rodamientos de nylon. Ideales para colegios, universidades, anfiteatros,...

GB | Sash board

Enamelled chalk board/white board mounted upon a supporting structure in silver anodised aluminium on stand or wall fixation. The surface slide is guided through a cable transmission. The ideal communication tool for large scale presentations, lecture theatres,...

FR | Tableau guillotine

Tableau vert ou blanc émaillé monté sur une structure en aluminium anodisé couleur argent sur piètement ou fixation murale. La surface se déplace sur le profil par transmission par câbles. Pour une communication idéale dans les amphithéâtres, salles de congrès,...

DE | Pylonentafel

Grüne, emailierte Tafel, auf einer mattsilbernen, anodisierten Aluminiumstruktur, stehend und für Wandhalterung. Die Tafeln lassen sich mit einem Mechanismus von Seilzügen und Kunststoffrollen verbinden und lassen sich sehr leicht verschieben. Ideal für Schulen, Universitäten, grosse Auditorien etc.

IT | Lavagna a ghigliottina smaltata

Lavagna smaltata (verde o bianca) montata su un supporto in alluminio silver fissato a terra o a muro; la superficie scorrevole è guidata da un sistema a cavi; ideale per comunicazioni su larga scala, presentazioni, teatri, palestra, ecc.

PO | Quadro de guilhotina simples

Quadro verde/branco de aço vitrificado sobre uma estrutura de alumínio anodizado na cor prata mate, montada no chão e à parede. O quadro desliza e é guiado num perfil por um sistema de transmissão por cabos e rolamentos de nylon.

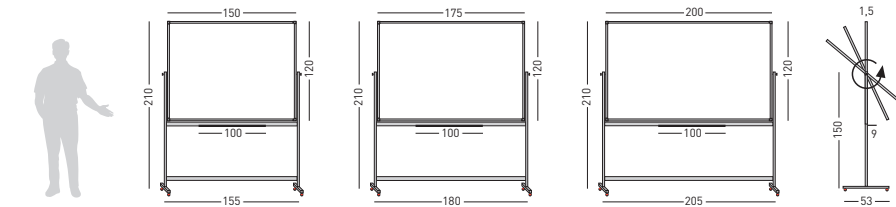

A	Height	Width	Depth	Weight
730/A/X1	210	120 x 150	1,5	100
730/A/X2	210	120 x 175	1,5	100
730/A/X3	210	120 x 200	1,5	100

B	Height	Width	Depth	Weight
730/X1	210	120 x 150	1,5	100
730/X2	210	120 x 175	1,5	100
730/X3	210	120 x 200	1,5	100

ES | Pizarra verde volteable

Pizarra verde volteable doble cara enmarcada con perfil de aluminio anodizado en color plata mate y cantoneras redondeadas de plástico gris. Superficie doble para escritura con tiza. Estructura metálica móvil provista de 4 ruedas (2 de ellas con freno).

FR | Tableau vert pivotant

Tableau rotatif vert avec encadrement en aluminium anodisé couleur argent et coins arrondis en plastic. Monté sur piétement double. Double surface pour écriture pour la craie. Support métallique mobile équipé de 4 roulettes (dont 2 à frein).

IT | Lavagna ribaltabile

Lavagna ribaltabile con cornice in alluminio anodizzato ed angoli arrotondati grigi in plastica. Superficie bifacciale. Supporto metallico mobile dotato di 4 ruote (di cui 2 con freno). Vassoio porta gessi di cm. 100 incluso.

GB | Revolving chalk board

Revolving chalk board equipped with silver anodised aluminium frame and plastic rounded corners. Double side surface. Metallic mobile support equipped with 4 castors (2 with brakes). A 100 cm. long pen tray included.

DE | Kreidedrehtafel

Kreidedrehtafel mit anodisiertem Aluminiumrahmen, silber eloxiert und abgerundeten grauen Kunststoffecken. Doppelseitige Schreiftafeloberfläche mit trocken abwischbaren Boardmarkern beschreibbar. Mobiles Fahrgestell mit 4 leichtgängigen Rollen (2 feststellbar).

PO | Quadro verde rotativo

Quadro verde rotativo de dupla face com perfil de alumínio anodizado na cor prata mate e cantos arredondados em plástico cinzento. Superfície dupla para escrita com giz. Estrutura metálica amovível com 4 rodas (2 delas com travão).

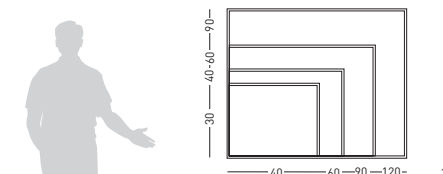
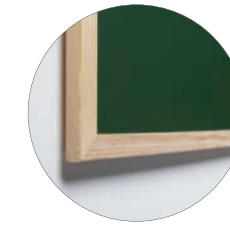

	Width	Height	Weight	Uts.
BL/ES/7371	30 x 40	1,4	40	
BL/ES/7371	40 x 60	1,4	20	
BL/ES/7371	60 x 90	1,4	10	
BL/ES/7371	90 x 120	1,4	6	

* Uts. per box

ES | Pizarra verde marco madera

Pizarra verde plastificada y rotulable con tiza, enmarcada con marco pino natural. Disponible en 4 medidas. Incluyen herrajes para sujeción.

FR | Tableau vert avec cadre en pin

Tableau vert en plastique et encadrée avec cadre en pin naturel pour écriture à la craie. Disponible en 4 dimensions. Comprend le matériel de fixation

IT | Lavagna verde con profilo in legno

Lavagna verde plastificata e scrivibile con gessetto, profilo in pino naturale. Disponibile in 4 misure. Inclusi elementi per fissaggio.

GB | Wood frame green bord

Plastic green bard for chalks and with pine wood frame available on 4 dimensions. Includes the screws kit.

DE | Grüne, eingeschweisste Tafel

Grüne, eingeschweisste Tafel, geeignet zum beschriften mit Kreide, Rahmen aus Pinienholz. Verfügbar in 4 Größen. Mit Beschlägen zum Anbringen.

PO | Quadro verde com perfil em madeira

Quadro verde plastificado e para utilização com giz, com perfil em madeira de pinho. Disponível em 4 medidas. Inclui ferragens para montagem.



	↑	→
735/1	40 x 60	2,3
735/2	60 x 80	2,3
735/3	80 x 120	2,3
735/4	100 x 120	2,3
735/5	120 x 150	2,3
735/6	120 x 200	2,3
735/7	120 x 250	2,3

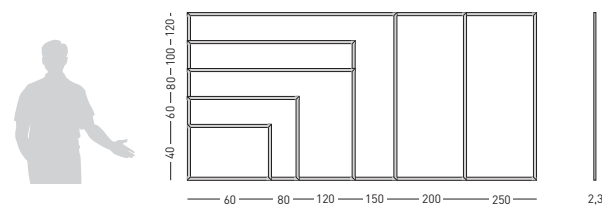

ES | Pizarra verde marco madera

Pizarra mural verde enmarcada en madera. Superficie laminada para escritura con tiza. La superficie laminada es óptima para uso frecuente. Ideal para escuelas y hostelería.

FR | Tableau laminé vert

Tableau vert avec encadrement en bois. Surface mélaminée pour écriture à la craie. La surface mélaminée est excellente pour un emploi fréquent. Idéal pour les écoles et l'hôtellerie.

IT | Lavagna laminata con cornice in legno

Lavagna con cornice in legno. La superficie è laminata, facile da pulire ed è ottima per un uso frequente. Ideale per scuole ed alberghi.

GB | Wood framed chalk board

Chalk board equipped with wood frame. Surface is laminated, easy to drywipe. The laminated surface is optimum for frequent use. Ideal for schools and hotel bussines.

DE | Laminierte Kreidetafel

Kreidetafel mit Holz-Rahmen. Laminierte Schreibtäfelberfläche mit Kreidebeschreibbar. Die laminierte Oberfläche ist vortrefflich für einen häufigen Gebrauch. Ideal für die Schüler und die Hotellerie.

PO | Quadro verde laminado aro em madeira

Quadro de parede verde com perfil em madeira. Superfície laminada para escrita com giz. A superfície laminada é ótima para uma utilização frequente. Ideal para escolas e hotelaria.

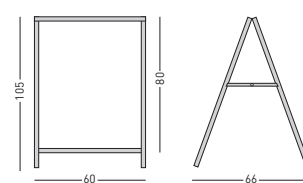

BL/ES/0060	105	60 x 80	66
------------	-----	---------	----

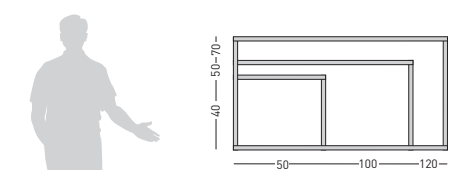

BL/ES/0051	40 x 50	2
BL/ES/0052	50 x 100	2
BL/ES/0053	70 x 120	2

ES | Pizarra wood frame

Gama de pizarras negras con marco de madera rústico. Aptas para escritura con tiza tradicional y con rotuladores de tinta líquida. Disponibles en versión mural o caballete doble cara.

FR | Tableau cadre en bois

Gamme de tableaux noir avec cadre en bois rustique. Convient pour écriture à la craie traditionnelle et stylos à encre liquide. Disponible en mural ou double face type chevalet.

IT | Lavagna con profilo in legno

Gamma di lavagne nere con profilo in legno rustico. Adatte per scrittura tradizionale con gessetti e con pennarelli con colore cancellabile. Disponibile in versione da parete o con cavalletto doppia-facciata.

GB | Wood frame board

Range of black boards with "antic" wood frame for traditional chalk or liquid ink pens writing. Wall or double side A board.

DE | Auswahl von schwarzen Tafeln

Auswahl von schwarzen Tafeln mit rustikalem Holzrahmen. Geeignet zum Schreiben mit Kreide oder Flüssigmarkern. Verfügbar als Wandmodell oder zweiseitig für ein Gestell.

PO | Quadro em madeira rústica

Gama de quadros pretos com aro em madeira rústica. Permite a escrita com giz tradicional ou com marcadores de tinta líquida. Disponível na versão de parede ou com cavalete dupla face.



A
Julieta

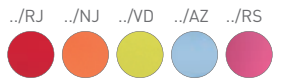
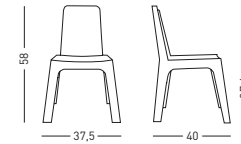

B
Mesa
Julieta

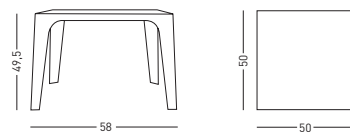
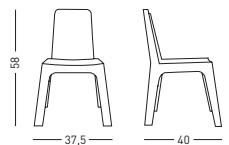
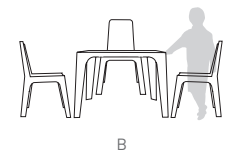
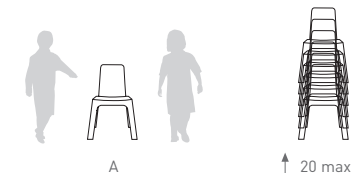
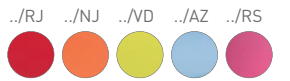
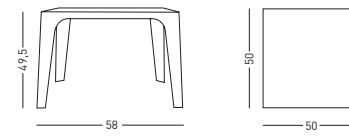

	↑	↔
JULIETA/01/RJ	58	37,5
JULIETA/01/NJ	58	37,5
JULIETA/01/VD	58	37,5
JULIETA/01/AZ	58	37,5
JULIETA/01/RS	58	37,5

	↑	↔
JULIETA/03/RJ	49,5	50
JULIETA/03/NJ	49,5	50
JULIETA/03/VD	49,5	50
JULIETA/03/AZ	49,5	50
JULIETA/03/RS	49,5	50

ES | Colección "Julieta"

Colección JULIETA apta para uso interior y exterior. Inyectada en poliamida de colores o policarbonato traslúcido de alta calidad y resistencia. Julieta y Julia son apilables. Tienen sistema de evacuación de agua y protección contra rayos UV.

FR | Collection "Julieta"

Collection JULIETA pour l'extérieur et intérieur. Polyamides injecté et en couleur ou en polycarbonate translucide haut de gamme et très résistant. Julieta et Julia sont empilables et ont un système d'évacuation de l'eau et résistant aux rayons UV.

IT | Collezione "Julieta"

Collezione JULIETA adatta all'uso interno ed esterno. In poliamide iniettato di colori o policarbonato traslucido di alta qualità e resistenza. Julieta e Julia sono impilabili. Hanno un sistema di evacuazione dell'acqua e protezione dai raggi UV.

GB | "Julieta" range

JULIETA range, suitable for indoor and outdoor, made of high quality and really resistant injected and coloured polypropilene or translucent polycarbonate. Julia & Julieta are stackable and have a system of water evacuation and protection against UV rays.

DE | Sammlung "Julieta"

Sammlung JULIETA für innen-und au, enbereich. In Farben-Polyamid oder in hochwertigem transluzent Polycarbonat gespritzt. Julieta und Julia sind stapelbar. Sie haben ein Wasser-Abfluss System und Schutz vor UV-Lichtstrahlen.

PO | Coleção "Julieta"

Coleção JULIETA fabricada para utilização em interior e exterior. Injetada em polipropileno de cores ou policarbonato translúcido de alta qualidade e resistência. Julieta e Julia são empilháveis. Têm um sistema de evacuação de água e protecção raios UV.

767
school

	↔	↑	↔	↔	↔
A 767/MA	68 x 73	40 x 55	3	2	
B 767/CO	92 x 81	40 x 55	3	2	
C 767/OS	75 x 103	75 x 55	3	4	
D 767/PI	90 x 112	75 x 55	3	4	
E 767/BU	100 x 140	75 x 75	3	6	
F 767/TO	126 x 108	75 x 75	3	6	

* LED optional



A



B



C



D



E



F

CHILD'S BOARDS



82

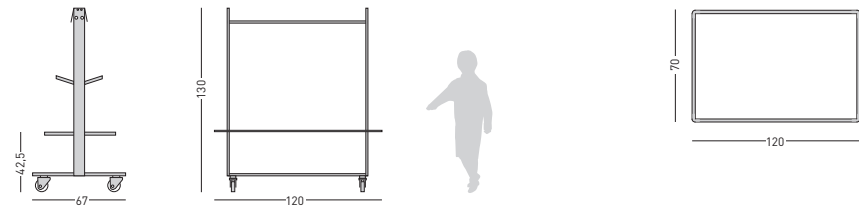

ES | Pizarras para niños
Sistema de pizarras murales o sobre soporte ideadas para niños en edades preescolares. Blancas o para tiza, lisas o con diversos motivos para niños. Fabricadas en Acero vitrificado a 800° garantizadas en escritura de por vida. El soporte incluye cajetín reposapennas y ruedas.

GB | Children board
Wall mounted or on a stand board designed for the children in pre-school. Available in white or green or with a background for children. Made of enamelled steel cooked at 800° writing surface with lifetime guaranteed. The structure include four wheels.

FR | Tableaux pour les enfants
Gamme de tableau muraux ou sur support conçu pour les enfants d'âge préscolaire. Pour la craie ou en surface blanche ou uni ou avec différents motifs pour les enfants. Fabriqué en acier emmaillé à 800° garantie à vie. Le support comprend un auget porte feutres et craies et roulettes.

DE | Tafeln für die Wand oder ein Gestell
System von Tafeln geeignet für die Wand oder auch für ein Gestell, entwickelt für Kinder im Vorschulalter. Weiss oder für Kreide und glatt, mit verschiedenen Motiven für Kinder. Gehärtet bei 800- Grad, unbegrenzte Garantie. Das Gestell beinhaltet Stiftablage und Rollen.

IT | Lavagne ideale per bambini
Sistema di lavagne a muro o con supporto ideale per bambini in età prescolare. Bianca o per gesso con diversi motivi per bambini. Realizzato in acciaio vetrificato a 800°C garantito sulla scrittura a vita. Il supporto include un piccolo appoggio per pennarelli e ruote.

PO | Quadro para crianças
Sistema de quadros para parede ou sobre suportes idealizados para crianças em idade pré-escolar. Brancos ou para giz e lisas ou com diversos desenhos para crianças. Fabricadas em Aço Vitrificado a 800°C com garantia vitalícia. Inclui suporte para marcadores e rodas.

A
grass



730/CH/GRS 70 x 120 67

B
street

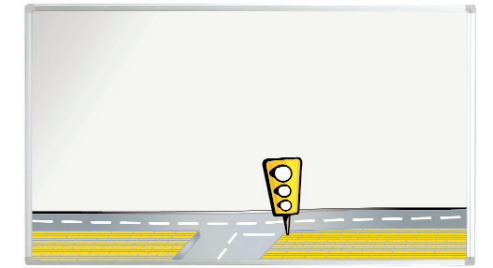

730/CH/STR 70 x 120 67

C
beach



730/CH/BEC 70 x 120 67

D
sea



730/CH/SEA 70 x 120 67

E
white



730/CH/PB 70 x 120 67

F
grey



730/CH/PG 70 x 120 67

G
support



730/CH/S 120 x 130 67

83



	↑↓	↔	↔	∅
A Z&O/110	225	-	-	30 x 60
B Z&O/111	75	-	-	30
C Z&O/401	-	60 x 90	2	-

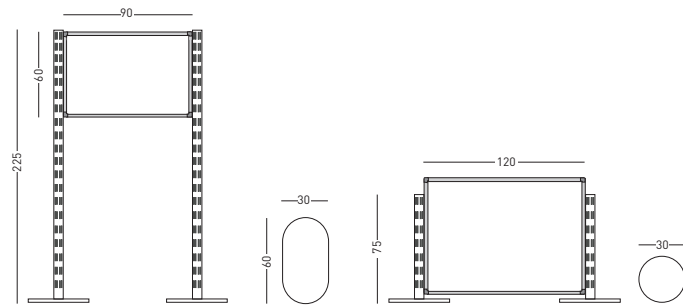

ES | Zeb & Olly Kids corner

Sistema modular ideal para el entretenimiento de los mas pequeños en lugares como aeropuertos, centros comerciales, espacios para fiestas de cumpleaños, etc... Las pizarras están fabricadas en Acero Vitrificado a 800° y enmarcadas con perfil de aluminio con cantoneras grises.

GB | Zeb & Olly Kids corner

Modular system Zeb and Olly corners. Ideal to entertain kids and children in airport, malls, restaurants and party areas, birthdays...The board are made of enamelled steel 800° surface and with aluminium frame and grey plastic corners. Zeb And Olly printed on one side and the other will be white plain.

FR | Zeb & Olly coin enfants

Coin dédiée aux enfants, Zeb & Olly. Système modulaire, idéal pour le divertissement des plus petits dans des lieux tels que les aéroports, les centres commerciaux, les fêtes d'anniversaire... Les tableaux sont fabriqués en acier émaillé à 800° et cadre profilés en aluminium gris et coins plastique.

DE | Zeb & Olly Kids corner

Zeb & Olly Kids corner, Baukasten, ideal als Zeitvertreib für die Kleinsten in Orten wie z.B. Airports, Kaufhäuser, Geburtstagsfeiern etc... Die Tafel sind aus einem mit 800- Grad gehärtetem Stahl hergestellt, haben einem Aluminiumrahmen und graue, abgerundete Kunststoffecken.

IT | Zeb & Olly angolo bimbi

Sistema modulare ideale per l'intrattenimento dei più piccoli in aree come aeroporti, centri commerciali, spazi per feste e compleanni, etc. Le lavagne sono realizzate in acciaio vetrificato a 800°C e con profilo in alluminio e raccordi angolari grigi.

PO | Zeb & Olly Kids corner

Sistema modular ideal para o entretenimento dos mais pequenos em locais como aeroportos, centros comerciais, espaços para festas de aniversário, etc... Os quadros estão fabricados em aço vitrificado a 800°C e com perfil em alumínio com cantos cinzentos. Serigrafia de Z&O numa face e a outra lisa.

A
corner



Z&O/401 60 x 90 2

B
butterfly



Z&O/402 80 x 120 2

C
moto



Z&O/403 80 x 120 2

D
face



Z&O/404 80 x 120 2

E
white

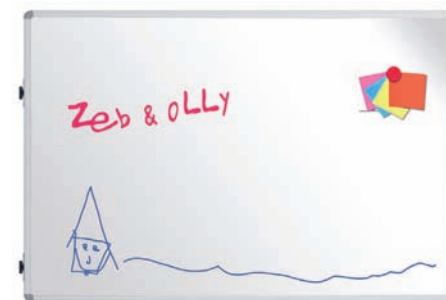

Z&O/420 80 x 120 2

F
grey

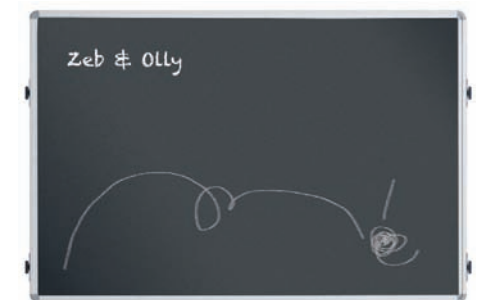

Z&O/421 80 x 120 2

G
support

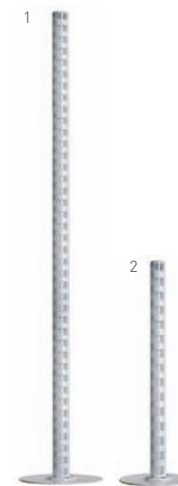

	↑↓	∅
1 Z&O/110	225	30 x 60
2 Z&O/111	75	30

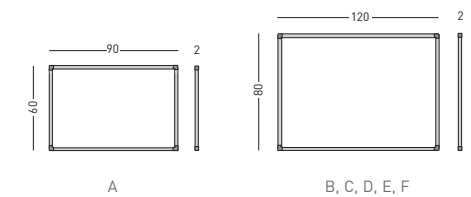



ES | Zeb & Olly Kids corner
Sistema modular ideal para el entretenimiento de los mas pequeños en lugares como aeropuertos, centros comerciales, espacios para fiestas de cumpleaños, etc... Las pizarras están fabricadas en Acero Vitrificado a 800° y enmarcadas con perfil de aluminio con cantoneras grises.

GB | Zeb & Olly Kids corner
Modular system Zeb and Olly corners. Ideal to entertain kids and children in airport, malls, restaurants and party areas, birthdays...The board are made of enamelled steel 800° surface and with aluminium frame and grey plastic corners. Zeb And Olly printed on one side and the other will be white plain.

FR | Zeb & Olly coin enfants
Coin dédiée aux enfants, Zeb & Olly. Système modulaire, idéal pour le divertissement des plus petits dans des lieux tels que les aéroports, les centres commerciaux, les fêtes d'anniversaire... Les tableaux sont fabriqués en acier émaillé à 800° et cadre profilés en aluminium gris et coins plastique.

DE | Zeb & Olly Kids corner
Zeb & Olly Kids corner, Baukasten, ideal als Zeitvertreib für die Kleinsten in Orten wie z.B. Airports, Kaufhäuser, Geburtstagsfeiern etc.. Die Tafel sind aus einem mit 800- Grad gehärtetem Stahl hergestellt, haben einem Aluminiumrahmen und graue, abgerundete Kunststoffecken.

IT | Zeb & Olly angolo bimbi
Sistema modulare ideale per l'intrattenimento dei più piccoli in aree come aeroporti, centri commerciali, spazi per feste e compleanni, etc. Le lavagne sono realizzate in acciaio vitrificato a 800°C e con profilo in alluminio e raccordi angolari grigi.

PO | Zeb & Olly Kids corner
Sistema modular ideal para o entretenimento dos mais pequenos em locais como aeroportos, centros comerciais, espaços para festas de aniversário, etc... Os quadros estão fabricados em aço vitrificado a 800°C e com perfil em alumínio com cantos cinzentos. Serigrafia de Z&O numa face e a outra lisa.



BL/ES/0061



ES | Tinta líquida blanca
Caja de 3 unidades de tinta líquida blanca

GB | White liquid ink
Box 3 units white liquid ink

FR | Encre blanche liquide
Boîte de 3 unités d'encre blanche liquide

DE | Weiße Flüssigkeit Tinte
Box 3 Einheiten weiße Flüssigkeit Tinte

IT | Inchiostro liquido bianco
Confezione 3 unità di inchiostro liquido bianco

PO | Tinta líquida branca
Caixa de 3 unidades de tinta líquida branca



BL/ES/0062

ES | Tinta líquida de colores
Caja de 5 unidades de tinta líquida de colores

GB | Liquid ink colours
Box of 5 units of liquid ink colours

FR | Encre liquide de couleur
Boîte de 5 unités de couleurs d'encre liquide

DE | Flüssige Druckfarben
Box 5 Einheiten von flüssiger Tinte Farben

IT | Colori di inchiostro liquido
Confezione da 5 unità di colori di inchiostro liquido

PO | Cores de tinta líquida
Caixa de 5 unidades de cores de tinta líquida



7006



ES | Borrador de aluminio magnético
Borrador de aluminio magnético. Filtro intercambiable.

GB | Magnetic whiteboard eraser
Magnetic aluminium eraser. The filters are replaceable.

FR | Effaceur magnétique
Effaceur magnétique en aluminium. Feutrine remplaçable.

DE | Magnetischer Whiteboard-Löcher
Magnetischer Tafelwischer. Mit auswechselbaren Löschblättern.

IT | Cancellino magnetico in alluminio
Cancellino magnetico (alluminio).

PO | Apagador magnético aluminio
Apagador magnético (alumínio).

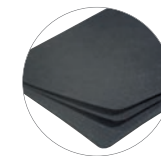

7006/1

ES | Recambio para borrador de aluminio
Bolsa 20 uds. de fieltros para borrador ref. 7006 y 7012.

GB | Aluminium eraser refills
Pack 20 felt refills for aluminium erasers ref. 7006 / 7012.

FR | Feutrines remplacement pour effaceur
Jeu 20 unités de feutrines pour effaceur ref. 7006 et 7012.

DE | Löschpapier für aluminium-tafelwischer
20 Löschblätter für Art. 7006 und 7012.

IT | Ricambio di feltri per cancellino
Ricambio di n. 20 feltri per cancellino in alluminio.

PO | Recarga para apagador
Recarga de 20 unidades para apagador.



7013/B

ES | Tiza blanca
Caja de 10 unidades de tizas blancas.

GB | White chalk
Pack of 10 white chalk.

FR | Craie blanche
Boîte de 10 craies blanches.

DE | Weiße Kreide
10 weiße Kreide.

IT | Gessetti bianchi
Pacco da 10 gessetti bianchi 6 x 8,5 x 2 cm.

PO | Giz branco
Caixa com 10 unid. de giz branco.



7013/C

ES | Tiza de color
Caja de 10 unidades de tizas de colores.

GB | Colour chalk
Pack of 10 colour chalk.

FR | Craie de couleurs
Boîte de 10 craies de couleurs.

DE | Farbige Kreide
10 farbige Kreide.

IT | Gessetti colorati
Pacco da 10 gessetti colorati 6 x 8,5 x 2 cm.

PO | Giz de cores
Caixa com 10 unid. de giz de cores sortidas.



7014



ES | Borrador de plástico
Borrador de plástico para pizarras. Filtro intercambiable.

GB | Plastic eraser
Plastic eraser for boards. The filters are replaceable.

FR | Effaceur de plastique
Effaceur en plastique pour tableaux. Feutrine remplaçable.

DE | Whiteboard-Löcher
Plastik Tafelwischer. Mit auswechselbarem Streifen.

IT | Cancellino in plastica
Cancellino in plastica 15 x 5 cm.

PO | Apagador de plástico
Apagador de plástico.

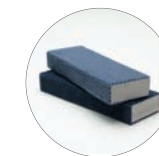

7014/1

ES | Recambio para borrador de plástico
2 uds. de fieltros de recambio para borrador ref. 7014.

GB | Plastic eraser refill
Box of 2 refills for board eraser ref. 7014.

FR | Feutrines de remplacement effaceur
Jeu de 2 unités de feutrines pour effaceur réf. 7014.

DE | Löschpapier für plastik-tafelwischer
2 Löschblätter für Tafelwischer ref. 7014.

IT | Ricambio per cancellino
Ricambio per cancellino in plastica ref. 7014.

PO | Recarga para apagador de plástico
Recarga para apagador de plástico ref. 7014.



7003 - 7003/30

ES | Cajetin de aluminio
Cajetin de aluminio de 100 ó 30 cm.

GB | Aluminium tray
100 cm. or 30 cm. long aluminium pen tray.

FR | Auget porte marqueurs
Auges en aluminium, porte-marqueurs 100 cm. ou 30 cm.

DE | Aluminium stiftablage
Aluminium 100 oder 30 cm. mit Kunststoffecken.

IT | Porta pennarelli in alluminio
Porta pennarelli in alluminio 100 e 30 cm.

PO | Suporte para marcadores
Suporte para marcadores 100 o 30 cm.