

# 03

## Informplan

- ES| Tableros de información
- GB| Notice boards
- FR| Tableaux d'information
- DE| Pinntafeln
- IT| Tavole di informazione
- PO| Quadros de informação

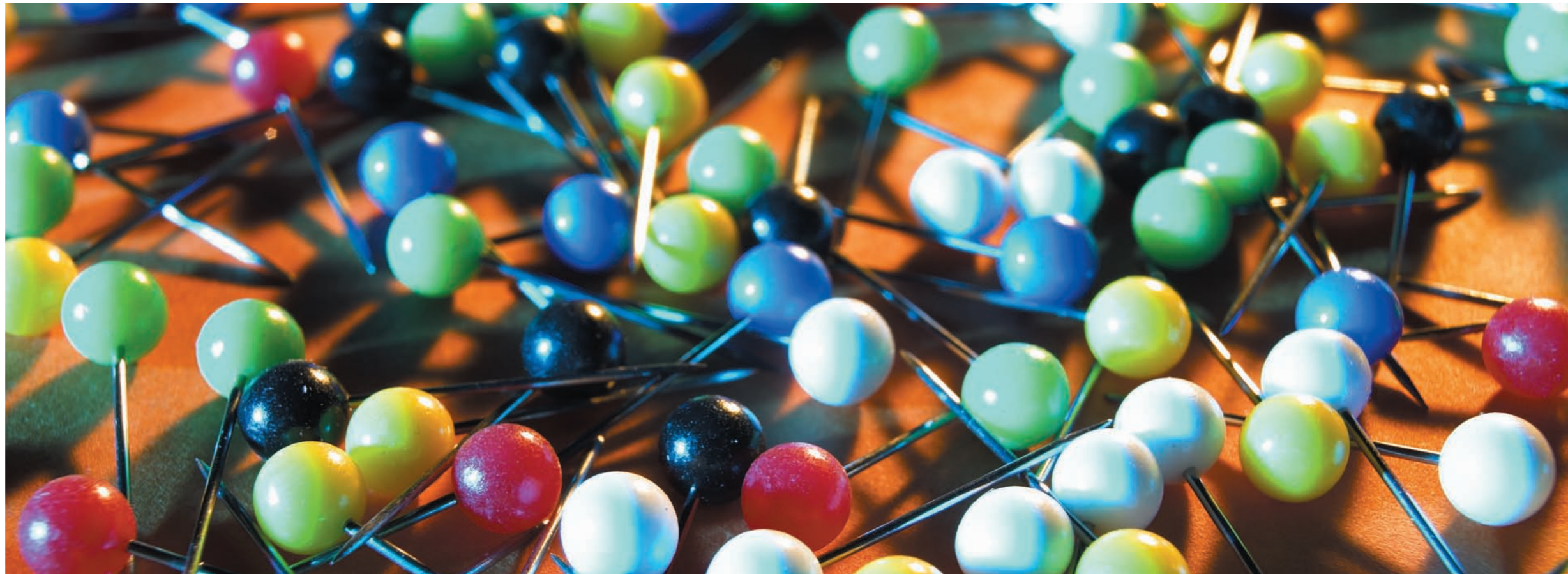

**ES| Tableros de información**  
Gama de productos destinados a la exposición y comunicación mediante los documentos expuestos sobre su superficie. Tableros de anuncios murales y con soporte, de corcho o tapizados, vitrinas de anuncios con gran variedad de aperturas de puerta, etc. Hacen de esta gama de productos, el complemento ideal para cualquier espacio ya sea público o privado. La extensa gama de referencias permiten cubrir tanto los espacios interiores como exteriores, pudiendo así, situar información a la intemperie.



**FR| Tableaux d'information**  
Une gamme de produit destiné aux expositions et à la communication de tous les jours et autour de nous. Tableaux d'affichage muraux ou avec piétements, en liège ou tapissé, vitrines d'affichage avec différents types d'ouverture et portes... font de cette famille de produit le complément idéal pour la communication d'un espace qu'il soit public ou privé à l'intérieur ou extérieur et ce même face aux intempéries.



**IT| Tavole di informazione**  
Questa linea di prodotti si rivolge ad eventi fieristici ed al settore della comunicazione. Tabbelle per muro o/e con supporto, fatte di sughero o pannello, vetrine con diverse varietà di aperture... fanno di questa gamma un ideale complemento per ogni area pubblica o privata, per spazi interni od esterni. Questa estensiva gamma di referenze permette di proteggere le informazioni anche dal cattivo tempo.



**GB| Notice boards**  
This product range is directed to exhibitions events and the communication sector. Notice boards for wall or with support, made of cork or felt, display showcases with a large varieties of opening doors,... make of this product range, the ideal complement for any public or private areas as well the interior space as the exterior ones. For outside references the information is protected from the bad weather.



**DE| Pinntafeln**  
Produktpalette, die an die Ausstellung und Kommunikation von Dokumenten gerichtet wird. Wand- oder Stativpinntafeln, mit oder ohne Korkoberfläche, Vitrine mit einer ausgedehnten Vielzahl von Öffnungssysteme, etc. Diese Produktpalette bildet eine ideale Ergänzung von jedem öffentlichen oder privaten Raum. Die ganze Produkte erlaubt dem Benutzer, ein umfangreiches Produktangebot vom Innen und Aussenräumen zu bedecken, und folglich.



**PO| Quadros de informação**  
Gama de produtos destinados à exposição e comunicação mediante documentos expostos sobre a sua superfície. Quadros para anúncios de parede e com suporte, de cortiça ou forrados, vitrinas de anúncios com grande variedade de aberturas de portas, etc... Fazem desta gama de produtos o complemento ideal para qualquer espaço, seja público ou privado. A extensa gama de referências permite cobrir tanto os espaços interiores como exteriores, permitindo assim preservar informação das intempéries.



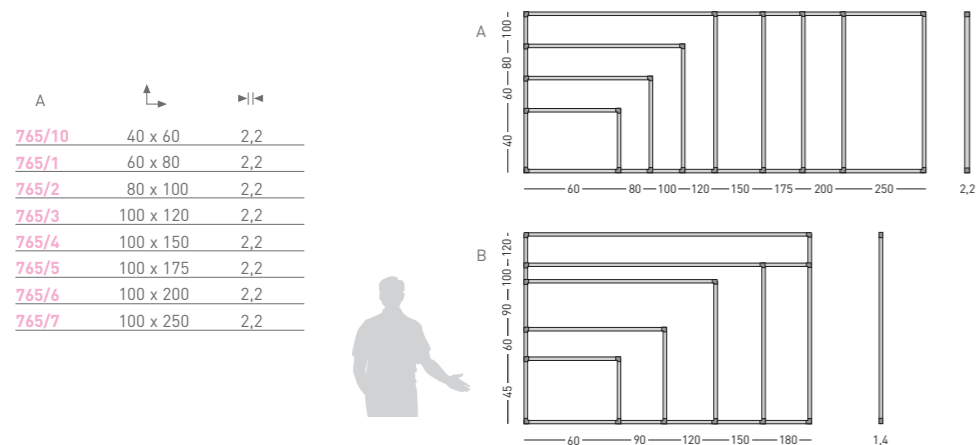
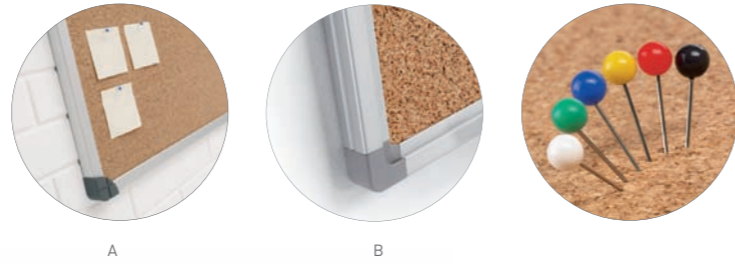

ES | Tablero de corcho  
Tablero de anuncios mural con base de corcho natural, enmarcado con perfil de aluminio anodizado en color plata mate y cantoneras redondeadas de plástico gris. Se pueden fijar sobre su superficie notas, avisos, etc. mediante agujas. Corcho de 5 mm. de grosor.

GB | Cork board  
Cork board equipped with silver anodised aluminium frame and grey plastic rounded corners. Ideal for pinning up notes, notices, posters, etc. Cork thickness: 5 mm.

FR | Tableau fond liège  
Tableau d'affichage en liège avec encadrement en aluminium anodisé couleur argent, coins arrondis en plastique gris. Idéal pour l'affichage de notes, avis, posters, etc... par épingles et punaises. Liège de 5 mm de très bonne qualité.

DE | Naturkorktafel  
Naturkorktafel mit anodisiertem Aluminiumrahmen, silber eloxiert und abgerundeten grauen Kunststoffecken. Ideal zum Anheften von Photos, Zetteln, Mitteilungen mittels Pinnadeln und Heftzwecke. Leichtes Einstecken und Herausziehen der Pinnadeln. 5 mm Kork.

IT | Lavagna in sughero  
Lavagna in sughero, con cornice in alluminio anodizzato ed angoli arrotondati in plastica grigi. Ideale per note, avvisi, poster, ecc. Sughero: 5 mm.

PO | Quadro de anúncios cortiça  
Quadro de anúncios com base em cortiça natural, perfil em alumínio na cor prata mate e cantos arredondados em plástico cinzento. Pode-se fixar na superfície mensagens, avisos, posters, etc. mediante a utilização de agulhas. Cortiça: 5 mm.

A  
rail

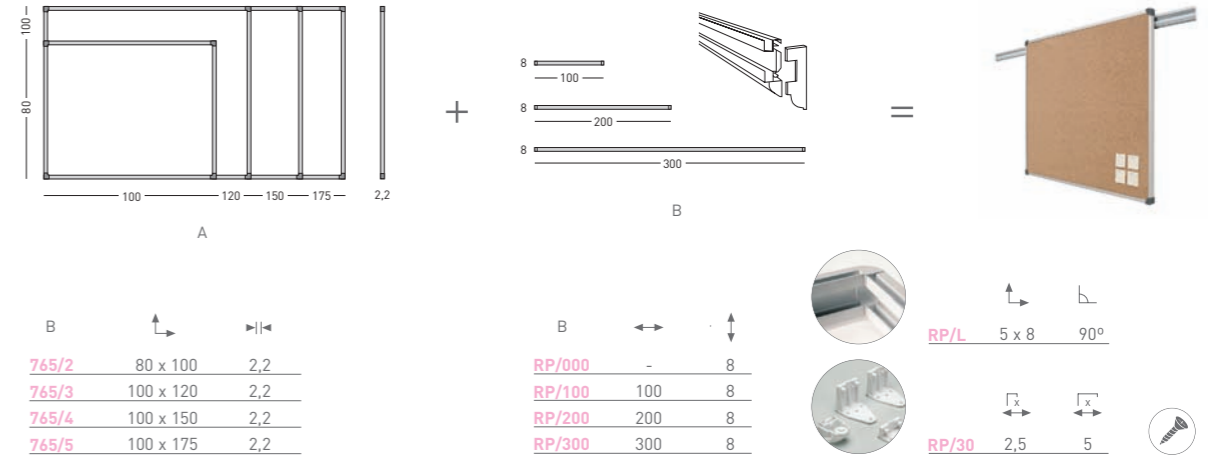

pg. 36-37

B  
T

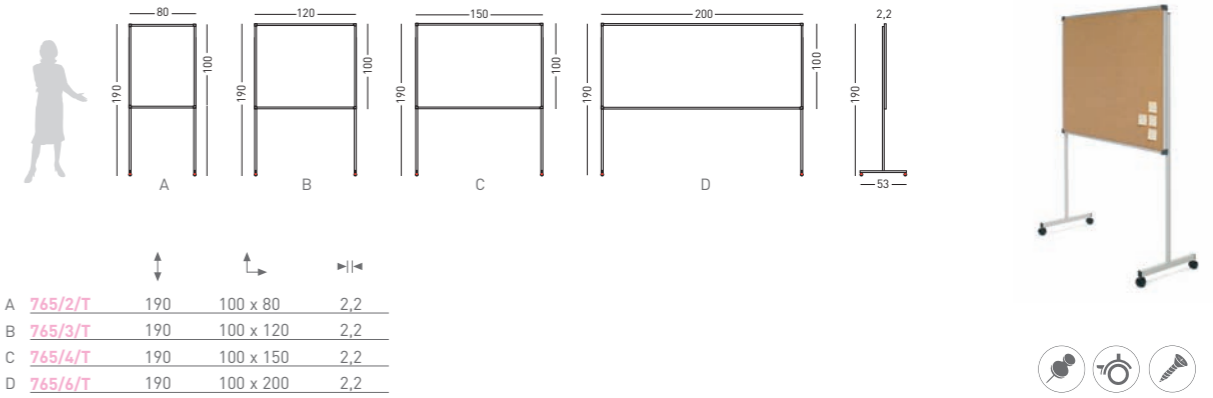

pg. 34

C  
Delta

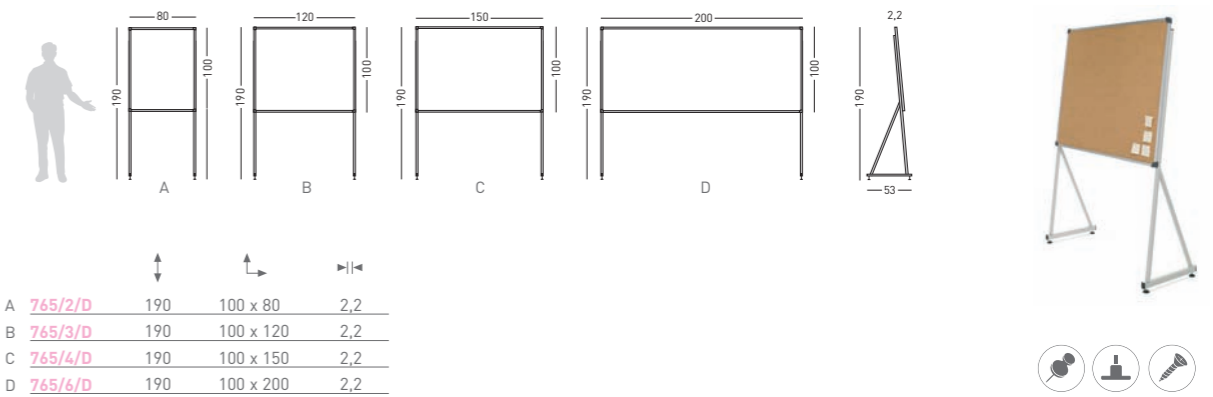

pg. 35

X  
acces



pg. 101

\* Ejemplos / Examples



760/10	40 x 60	2,2
760/1	60 x 80	2,2
760/2	80 x 100	2,2
760/3	100 x 120	2,2
760/4	100 x 150	2,2
760/5	100 x 175	2,2
760/6	100 x 200	2,2
760/7	100 x 250	2,2

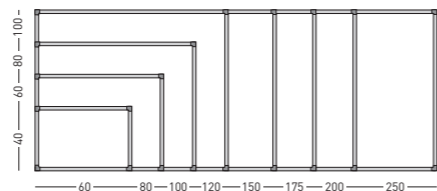

A  
rail

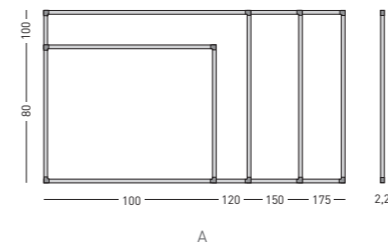

A		
760/2	80 x 100	2,2
760/3	100 x 120	2,2
760/4	100 x 150	2,2
760/5	100 x 175	2,2

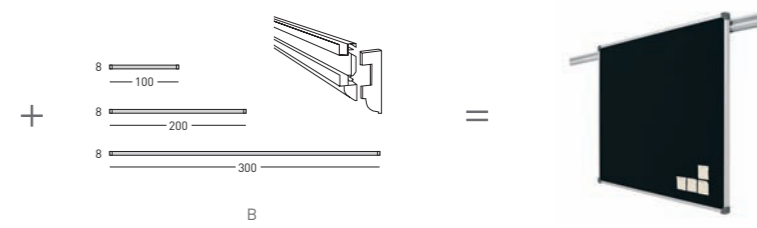

B		
RP/000	-	8
RP/100	100	8
RP/200	200	8
RP/300	300	8

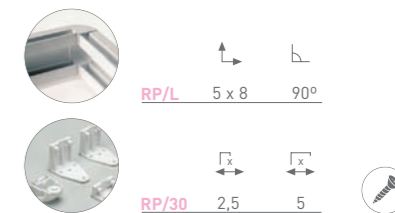

pg. 36-37

B  
T

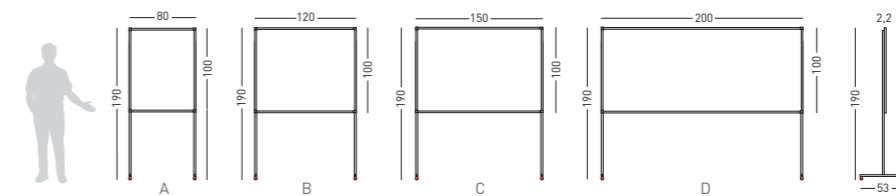

A			
760/2/T	190	100 x 80	2,2
760/3/T	190	100 x 120	2,2
760/4/T	190	100 x 150	2,2
760/6/T	190	100 x 200	2,2

pg. 34



C  
Delta

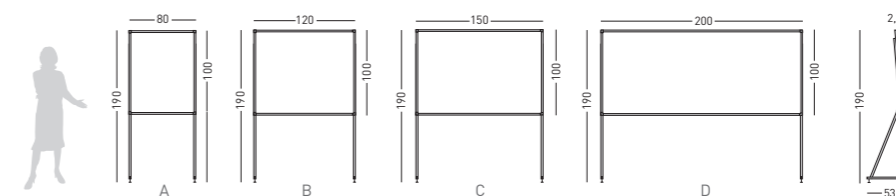

A			
760/2/D	190	100 x 80	2,2
760/3/D	190	100 x 120	2,2
760/4/D	190	100 x 150	2,2
760/6/D	190	100 x 200	2,2

pg. 35



ES | Tableros de corcho tapizado

Tablero de anuncios mural con base de corcho tapizado, enmarcado con perfil de aluminio anodizado en color plata mate y cantoneras redondeadas de plástico gris. Se pueden fijar sobre su superficie notas, avisos, pósters, etc, mediante agujas o chinchetas.

FR | Tableau fond liège tissu

Tableau d'affichage en liège fond tissu avec encadrement aluminium anodisé couleur argent et coins arrondis en plastique gris. Idéal pour l'affichage de notes, avis, posters, à l'aide d'épingles et punaises. Liège de 5 mm d'épaisseur de très bonne qualité.

IT | Lavagna con feltro

Lavagna con fondo in sughero ricoperto in feltro, con cornice in alluminio anodizzato ed angoli arrotondati in plastica grigia. Ideale per annotazioni multiple, poster, avvisi. Disponibile nelle finiture nero, bordeaux, blu, verde, grigio ed ocra.

GB | Felt board

Felt notice board with cork surface equipped with silver anodised aluminium frame and grey plastic rounded corners. Ideal for pinning up notes, notices, posters, etc. Covered with fabric in colours black, bordeaux, blue, green, grey and ochre.

DE | Textilpinn Tafeln

Stoffoberfläche Naturkorktafel mit anodisiertem Aluminiumrahmen, silber eloxiert und abgerundeten grauen Kunststoffecken. Ideal zum Anheften von Photos, Zetteln, Mitteilungen mittels Pinnadeln und Heftzwecke. Einstechen und Herausziehen der Pinnadeln.

PO | Quadro de anúncios forrado

Quadro de anúncios com base em cortiça forrada, perfil de alumínio anodizado na cor prata mate e cantos arredondados em plástico cinzento. Pode-se fixar na superfície mensagens, avisos, posters, etc, mediante a utilização de agulhas.

X  
acces



7051/S



PF/A4/M - PF/A5/M  
pg. 194-195



A4/M - A5/M  
pg. 192-193

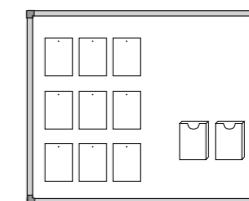

\* Ejemplos / Examples

pg. 101

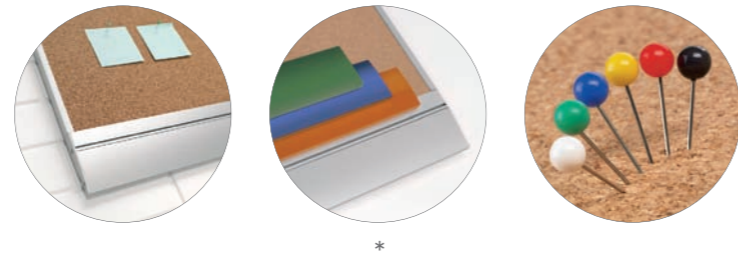

94



*	↕	↔	↗
Z/765/10	40 x 60	53 x 61	2,3
Z/765/1	60 x 80	73 x 81	2,3
Z/765/2	80 x 100	93 x 101	2,3
Z/765/3	100 x 120	113 x 121	2,3
Z/765/4	100 x 150	113 x 151	2,3
Z/765/5	100 x 175	113 x 176	2,3
Z/765/6	100 x 200	113 x 201	2,3
Z/765/7	100 x 250	113 x 251	2,3

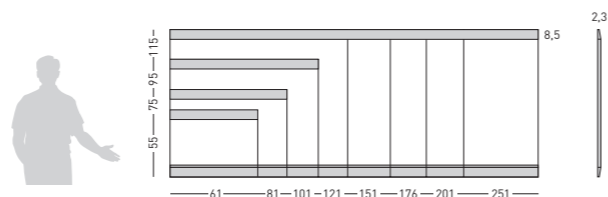

ES | Tablero "Zénit" de corcho natural

Tablero de corcho mural Zénit enmarcado con perfil de aluminio anodizado en color plata mate (personalizable). Superficie de corcho natural. Se pueden fijar sobre su superficie notas, avisos, pósters, etc. mediante agujas o chinchetas.

FR | Tableau d'affichage "Zénit" en liège

Tableau d'affichage en liège avec encadrement en aluminium anodisé (personnalisable). Liège de 5 mm, très bonne qualité. Idéal pour l'affichage de notes, avis, posters, à l'aide d'épingles et punaises.

IT | Pannello "Zénit" sughero naturale

Pannello da parete in sughero Zénit con cornice di alluminio anodizzato colore argento opaco (personalizzabile). Superficie in sughero naturale. Ideale per annotazioni multiple, poster, avvisi.

GB | Cork notice board "Zénit"

Wall cork notice board with anodized silver colour aluminium frame (customizable). Cork 5 mm thick, high quality pinable surface. Ideal for pinning up notes, notices, posters, etc.

DE | Werbewandtafel aus natürlichem "Zénit"

Korktafel mit mattsilbernen Aluminiumrahmen. Oberfläche aus natürlichem Kork. Ideal zum Anheften von Photos, Zetteln, Mitteilungen mittels Pinnadeln und Heftzwecke.

PO | Quadro de anúncios "Zénit" em cortiça

Quadro de anúncios de parede Zénit com perfil em alumínio anodizado na cor prata mate (personalizável). Superfície em cortiça natural. Pode-se fixar na superfície mensagens, avisos, posters, etc. mediante a utilização de agulhas.

A  
rail

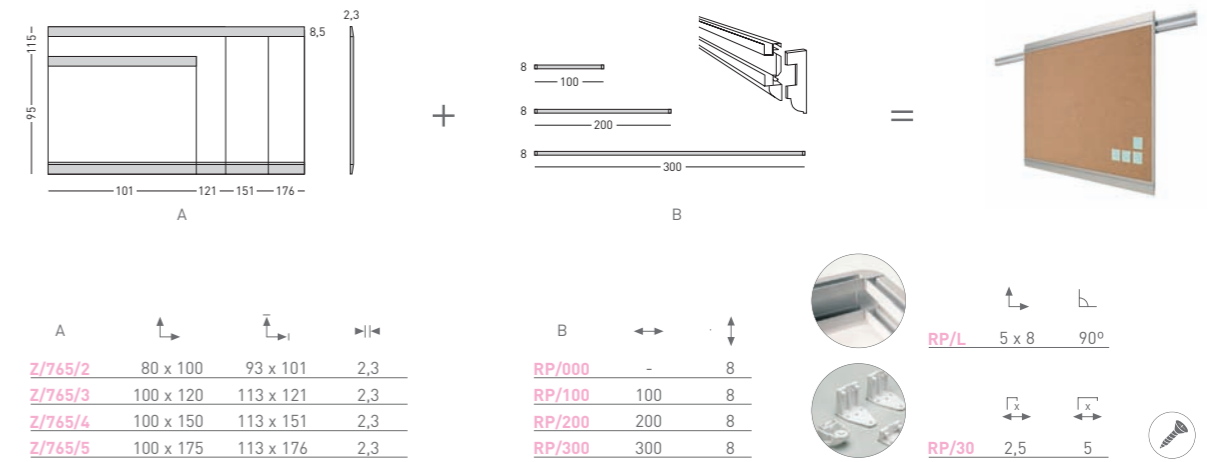

pg. 36-37

A	↕	↔	↗	↘
Z/765/2	80 x 100	93 x 101	2,3	
Z/765/3	100 x 120	113 x 121	2,3	
Z/765/4	100 x 150	113 x 151	2,3	
Z/765/5	100 x 175	113 x 176	2,3	

B	↔	↕
RP/000	-	8
RP/100	100	8
RP/200	200	8
RP/300	300	8

RP/L	↔	↕
5 x 8	90°	
RP/30	2,5	5

B  
Y2

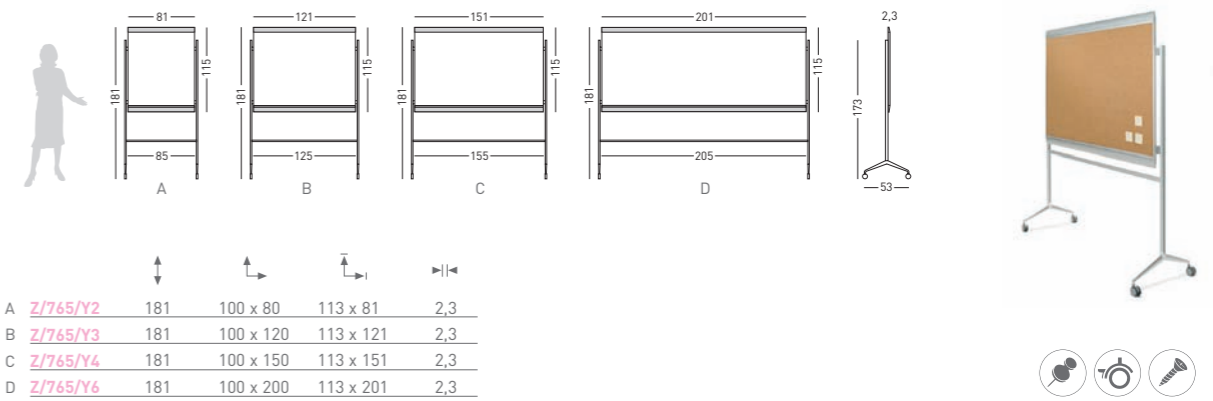

pg. 34

A	↕	↔	↗	↘
Z/765/Y2	181	100 x 80	113 x 81	2,3
Z/765/Y3	181	100 x 120	113 x 121	2,3
Z/765/Y4	181	100 x 150	113 x 151	2,3
Z/765/Y6	181	100 x 200	113 x 201	2,3

C  
ILUM

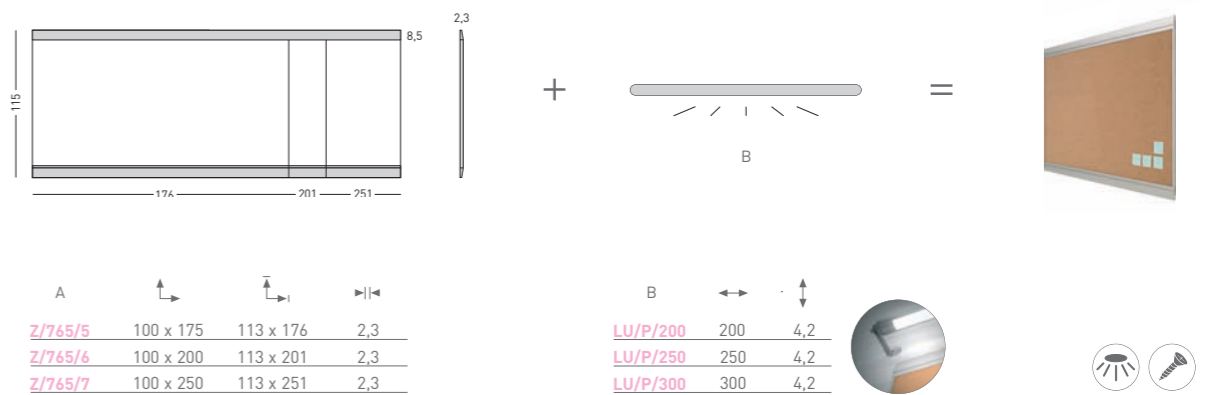

A	↕	↔	↗	↘
Z/765/5	100 x 175	113 x 176	2,3	
Z/765/6	100 x 200	113 x 201	2,3	
Z/765/7	100 x 250	113 x 251	2,3	

B	↔	↕
LU/P/200	200	4,2
LU/P/250	250	4,2
LU/P/300	300	4,2

X  
acces

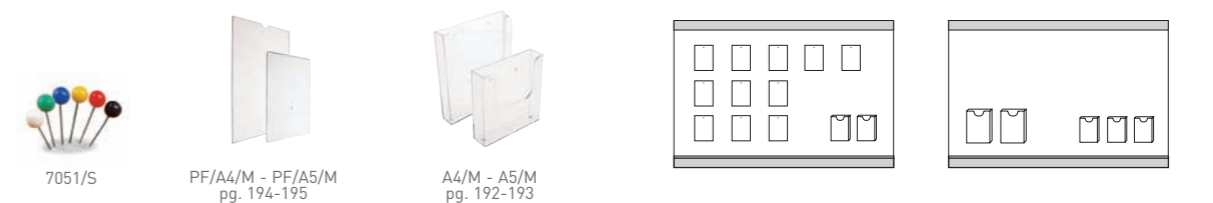

pg. 101

95

# ZENIT

PS design

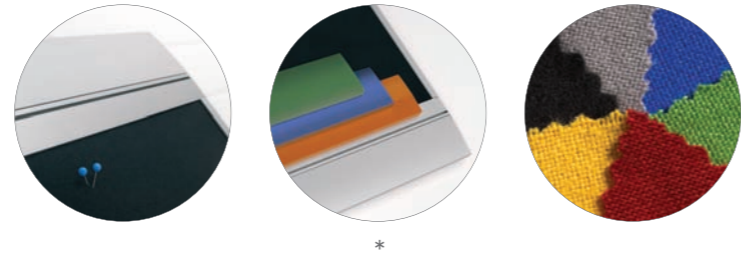

*	↕	↔	↔
Z/760/10	40 x 60	53 x 61	2,3
Z/760/1	60 x 80	73 x 81	2,3
Z/760/2	80 x 100	93 x 101	2,3
Z/760/3	100 x 120	113 x 121	2,3
Z/760/4	100 x 150	113 x 151	2,3
Z/760/5	100 x 175	113 x 176	2,3
Z/760/6	100 x 200	113 x 201	2,3
Z/760/7	100 x 250	113 x 251	2,3

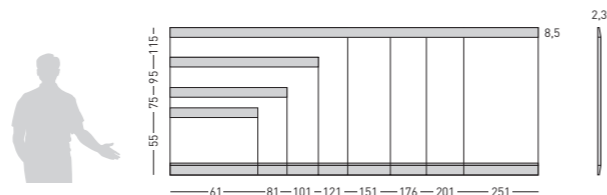

**ES** | Tablero "Zénit" de corcho tapizado  
Tablero de corcho Zénit enmarcado con perfil de aluminio anodizado en color plata (tapa personalizable). Superficie de corcho tapizada en colores. Se pueden fijar sobre su superficie notas, avisos, pósters, etc. mediante agujas o chinchetas.

**GB** | Cork notice board "Zénit"  
Cork notice board, covered with colored fabric, with anodized aluminium frame (customizable). Cork 5 mm, high quality. Ideal for pinning up notes, notices, posters, etc. Covered with fabric in colours black, bordeaux, blue, green, grey and ochre.

**FR** | Tableau d'affichage "Zénit" liège + tissu  
Tableau d'affichage avec fond liège + tissu de couleur. Encadrement en aluminium anodisé (personnalisable). Liège de 5 mm, très bonne qualité. Idéal pour l'affichage de notes, avis, posters, à l'aide d'épingles et punaises.

**DE** | Textilpinntafel, schwarz, "Zénit"  
Textilkorktafel mit mattsilbernen Aluminiumrahmen. Die Oberfläche ist mit schwarzem Stoff überzogen, darunter befindet sich natürlicher Kork. Ideal zum Anheften von Photos, Zetteln, Mitteilungen mittels Pinnadeln und Heftzwecke.

**IT** | Pannello "Zénit" con sfondo rivestito  
Pannello da parete in sughero Zénit con cornice di alluminio anodizzato colore argento opaco (personalizzabile). Superficie in sughero naturale ricoperta da colori. Ideale per annotazioni multiple, poster, avvisi.

**PO** | Quadro de anúncios "Zénit" forrado  
Quadro de anúncios de parede Zénit com perfil em alumínio anodizado na cor prata mate (personalizável). Superfície em cortiça forrada com cores. Pode-se fixar na superfície mensagens, avisos, posters, etc. mediante a utilização de agulhas.

## A rail

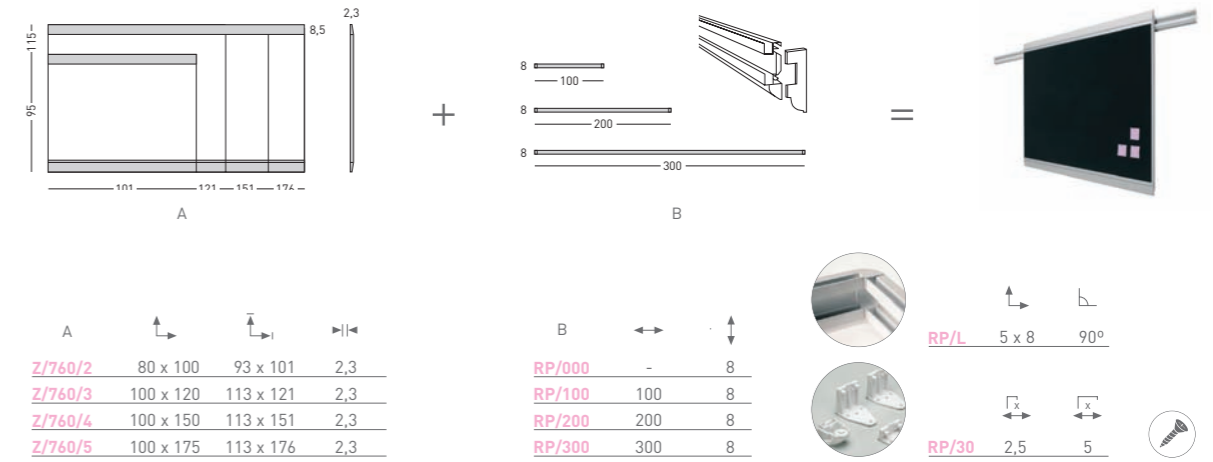

pg. 36-37

A	↕	↔	↔	↔
Z/760/2	80 x 100	93 x 101	2,3	
Z/760/3	100 x 120	113 x 121	2,3	
Z/760/4	100 x 150	113 x 151	2,3	
Z/760/5	100 x 175	113 x 176	2,3	

B	↔	↕
RP/000	-	8
RP/100	100	8
RP/200	200	8
RP/300	300	8

RP/L	↔	↕
5 x 8	90°	
RP/30	2,5	5

## B Y2

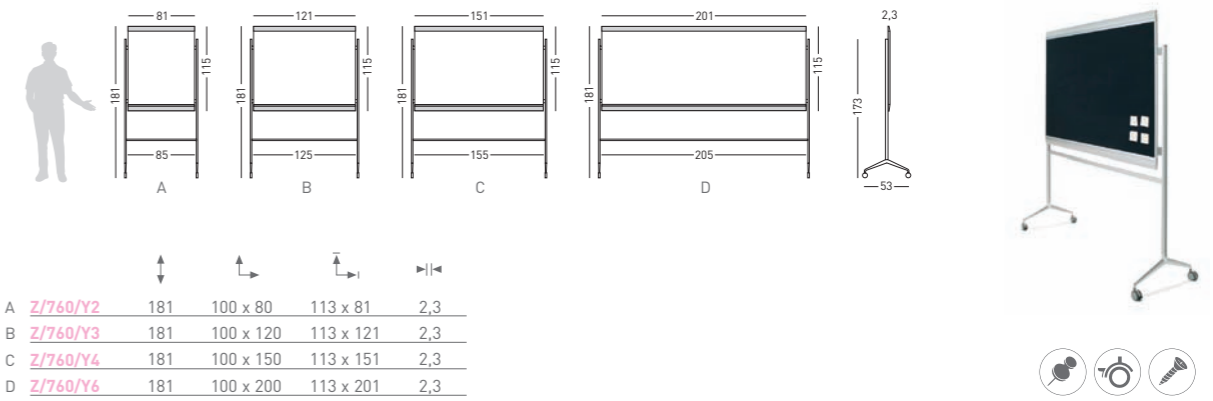

pg. 34

A	↕	↔	↔	↔
Z/760/Y2	181	100 x 80	113 x 81	2,3
B	181	100 x 120	113 x 121	2,3
C	181	100 x 150	113 x 151	2,3
D	181	100 x 200	113 x 201	2,3

## C iLUM

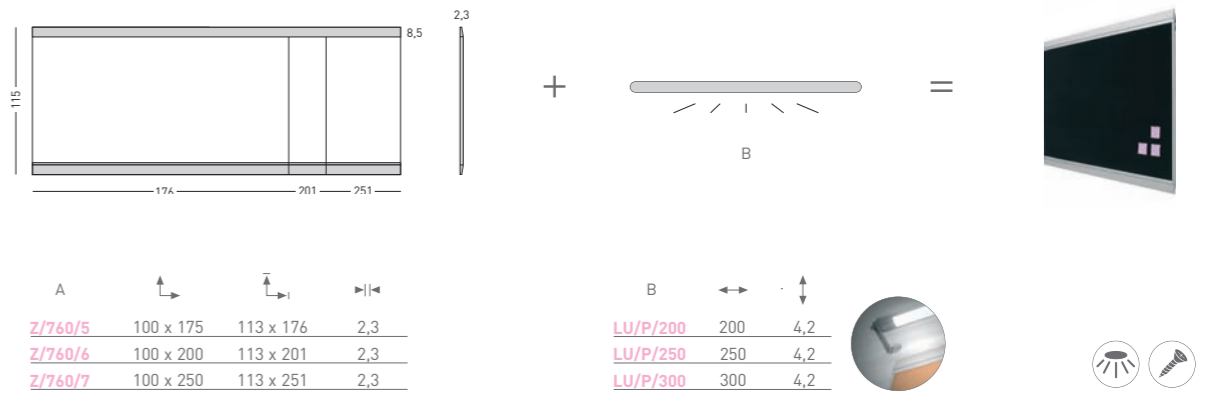

A	↕	↔	↔
Z/760/5	100 x 175	113 x 176	2,3
Z/760/6	100 x 200	113 x 201	2,3
Z/760/7	100 x 250	113 x 251	2,3

B	↔	↕
LU/P/200	200	4,2
LU/P/250	250	4,2
LU/P/300	300	4,2

## X acces

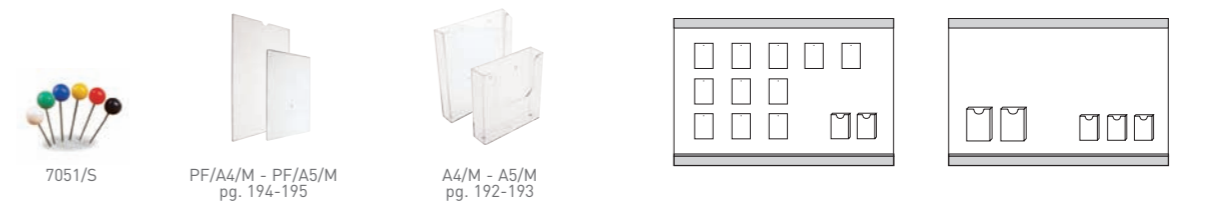

pg. 101

7051/S

PF/A4/M - PF/A5/M  
pg. 194-195

A4/M - A5/M  
pg. 192-193



	↑	→	←
BL/IN/0320	40 x 50	0,5	x2 units
BL/IN/0321	40 x 50	0,5	x2 units
BL/IN/0322	40 x 50	0,5	x2 units
BL/IN/0323	40 x 50	0,5	x2 units
BL/IN/0324	40 x 50	0,5	x2 units
BL/IN/0325	40 x 50	0,5	x2 units
BL/IN/0326	40 x 50	0,5	x2 units
BL/IN/0327	40 x 50	0,5	x2 units

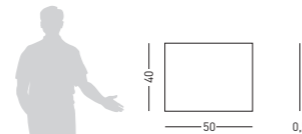

ES | Corchos autoadhesivos

Pack de 2 corchos autoadhesivos de 40 x 50 cm. pintados en colores. Ideal tanto para uso doméstico como para la oficina. Disponible en 8 colores.

FR | Pin wall

Pack de plaqueurs de liège autocollants de 40 x 50 cm. peints de couleurs. Idéal pour la maison et le bureau. Disponible en 8 couleurs.

IT | Pannelli autoadesivi

Confezione di 2 pannelli autoadesivi di 40x50 cm. colorati. Ideali sia per uso domestico, che per ufficio. Disponibile in 8 colori.

GB | Autoadhesive Cork

Set of auto adhesives painted in different colours cork plates 40 x 50 cm. Ideal for home or offices. 8 different colours.

DE | Paar selbstklebender Korktafeln

Paar selbstklebender Korktafeln, 40 x 50 cm, verschiedene Farben. Ebenso zu gebrauchen im Haushalt wie auch im Büro.

PO | Pin wall

Pack de 2 placas de cortiça adesivas com 40 x 50 cm. pintadas em cores. Ideal tanto para utilização doméstica como no escritório. Disponível em 8 cores.

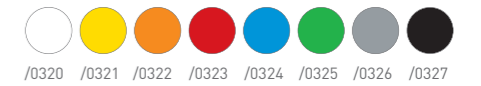

	↑	→	←
BL/IN/0420	45 x 500	0,5	
BL/IN/0421	45 x 500	0,5	
BL/IN/0422	45 x 500	0,5	
BL/IN/0423	45 x 500	0,5	
BL/IN/0424	45 x 500	0,5	
BL/IN/0425	45 x 500	0,5	
BL/IN/0426	45 x 500	0,5	
BL/IN/0427	45 x 500	0,5	

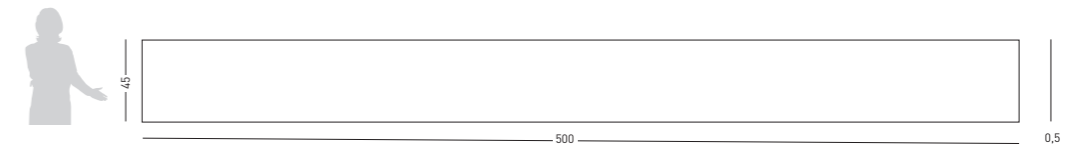

ES | Roller Cork

Rollo de corcho de 5 mm de grosor de 45 cm x 5 metros pintado de color. Disponible en 8 colores. Ideal tanto para uso doméstico como para la oficina.

FR | Roller Cork

Liège en rouleau de 5 mm d'épaisseur 45 cm x 5 mètres peints. Disponible en 8 couleurs. Idéal à la fois pour un usage domestique et pour le bureau.

IT | Pannelli arrotolati

Pannello arrotolato di 5mm. di spessore e 45 cm. x lunghezza 5 metri colorato. Ideale sia per uso domestico che per ufficio. Disponibile in 8 colori.

GB | Roller Cork

Roll or auto adhesive cork 5 mm thick 45 cm width x 5 meters and painted, available in 8 different colours. Ideal for homes or office.

DE | Korkrolle

5mm starke Korkrolle, 45 x 500cm, verfügbar in 8 Farben. Ebenso zu gebrauchen im Haushalt wie auch im Büro.

PO | Roller Cork

Rolo de cortiça com 5mm. de espessura com 45 cm. x 5 metros pintado com cor. Disponível em 8 cores. Ideal tanto para utilização doméstica como no escritório.



	↕	↔	Uts.
BL/IN/7771	30 x 40	1,4	40
BL/IN/7772	40 x 60	1,4	20
BL/IN/7773	60 x 90	1,4	10
BL/IN/7774	90 x 120	1,4	6

\*Uts. per box

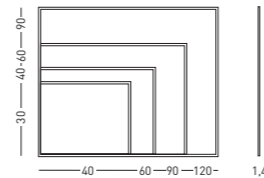

ES | **Tablero de corcho**  
Tablero de corcho natural con marco de pino barnizado. Disponible en 4 formatos. Incluye pins y herrajes de fijación. Ideal tanto para uso doméstico como para la oficina.

FR | **Liège avec cadre en pin**  
Tableau en liège naturel cadre en pin vernis. Disponible en 4 formats. Comprend matériel de fixation et punaises. Idéal pour la maison et le bureau.

IT | **Pannello in sughero**  
Pannello in sughero naturale con profilo in pino verniciato. Disponibile in 4 formati. Include puntine e ferramenta per il fissaggio. Ideale sia per uso domestico, che per ufficio.

GB | **Corkboard**  
Natural cork board with varnished pine wood frame. Available in 4 dimensions. Includes screw set. Ideal for homes and offices.

DE | **Platte aus Naturkork**  
Platte aus Naturkork mit einem lackiertem Pinienholzrahmen. Verfügbar in 8 Farben. Ebenso zu gebrauchen im Haushalt wie auch im Büro.

PO | **Quadro com aro em madeira**  
Quadro em cortiça com aro em madeira de pinho envernizada. Disponível em 4 formatos. Inclui pioneses e ferragens para aplicação na parede. Ideal tanto para utilização doméstica como no escritório.



# ACCES

ES | **Corchos autoadhesivos**  
Pack de 4 placas de corcho natural de 5 mm. autoadhesivos.

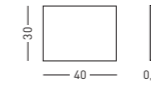

GB | **Adhesive cork plaques**  
Pack of 4 pieces of natural cork plaques (5 mm.) adhesives.

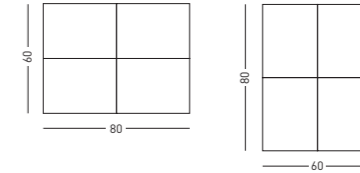

FR | **Panneaux d'affichage adhésifs**  
4 panneaux d'affichage adhésifs repositionnables (5 mm.)

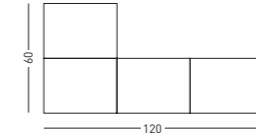

DE | **Selbstklebende Kork-Pinntafel**  
4 selbstklebende Kork-Pinntafel (5mm).

IT | **Pezzi di sughero autoadesivi**  
Pacco da 4 pezzi di sughero naturale adesivo. (5 mm.)

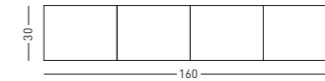

PO | **4 placas de cortiça auto-adesivas**  
Conjunto de 4 placas em cortiça natural com 5mm. auto-adesivas.].

↕ uds  
767 30 x 40 4

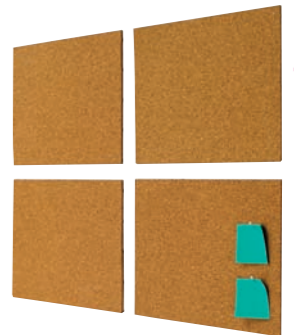

## Acces



7051/S

A

ES | **Caja de agujas**  
Caja de 100 uds. (negro, blanco, rojo, amarillo, verde y azul).

GB | **Box of pins**  
Box of 100 pins (black, white, red, yellow, green and blue).

FR | **Boîtes d'épingles**  
Boîte de 100 épingles (noir, blanc, rouge, jaune, vert et bleu).

DE | **Pinnadeln**  
100 Pinnadeln (Schwarz, Weiß, Rot, Gelb, Grün und Blau).

IT | **Scatola da puntine**  
Scatola da 100 puntine gialle per bacheche in sughero 1,5 cm.

PO | **Agulhas**  
Caixa com 100 agulhas (preto, branco, vermelho, amarelo, verde e azul).



7005

B

ES | **Rotuladores de pizarra**  
Pack 4 rotuladores borrado en seco (negro, rojo, verde y azul).

GB | **Whiteboard markers**  
Pack 4 whiteboard markers (black, red, green and blue).

FR | **Marqueurs effaçables à sec assortis**  
Boîte 4 marqueurs à sec (noir, rouge, vert et bleu).

DE | **Whiteboard-Markers**  
Lieferbar in 4 Farben sortiert (schwarz, rot, grün un blau).

IT | **Pennarelli a secco**  
Confezione da 4 pezzi (nero, rosso, verde ed azzurro).

PO | **Marcadores**  
Conjunto de 4 marcadores (preto, vermelho, azul e verde).



9002  
9003  
9004



C

ES | **Imanes**  
Caja de 6 unidades de imanes redondos Ø de: 2, 2,5 y 3,2 cm. Disponibles en 6 colores: Rojo, amarillo, blanco, verde, azul y naranja.

GB | **Magnets**  
Pack of 6 circular magnets 2, 2,5 y 3,2 cm. Ø. Available in 6 colours: red, yellow, white, green, blue and orange.

FR | **Aimants**  
Boîte de 6 aimants ronds 2, 2,5 y 3,2 cm. Ø. Disponible en 6 couleurs: rouge, jaune, blanc, vert, bleu et orange.

DE | **Rundmagnete**  
6 Rundmagnete 2, 2,5 y 3,2 cm. Ø. Lieferbare Farben: Rot, Gelb, Weiß, Grün, Blau und Orange.

IT | **Magnetini tondi**  
Pacchetto di magnetini tondi 2, 2,5 y 3,2 cm. Ø. (6 pezzi). Disponibile in 6 colori: rosso, giallo, bianco, verde, azzurro ed arancio.

PO | **Magnéticos redondos**  
Bolsa com 6 unidades de magnéticos redondos com Ø: 2, 2,5 e 3,2 cm. Disponível em 6 cores: vermelho, amarelo, branco, verde, azul e laranja.

	↕	↔	uds
A	7051/S	0,6	100
B	7005	-	4
C	9002	2	6
	9003	2,5	6
	9004	3,2	6



A	↕	↔	↔
765/V1	60 x 80	2,5	7
765/V2	80 x 100	2,5	7
765/V3	100 x 120	2,5	7
765/V4	100 x 150	2,5	7
765/V5	100 x 175	2,5	7
765/V6	100 x 200	2,5	7

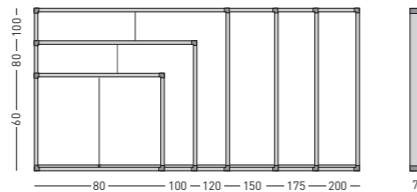

B	↕	↔	↔
720/V1	60 x 80	2,5	7
720/V2	80 x 100	2,5	7
720/V3	100 x 120	2,5	7
720/V4	100 x 150	2,5	7
720/V5	100 x 175	2,5	7
720/V6	100 x 200	2,5	7

**ES** | Vitrina de corcho con puertas correderas  
Vitrina de anuncios mural con fondo de corcho natural de 5 mm., marco de aluminio anodizado en color plata mate natural y cantoneras redondeadas de zamak gris, puertas correderas de metacrilato y cerradura con llave. Se pueden fijar sobre su superficie notas, avisos, etc.

**FR** | Vitrine fond liège avec portes coulissantes  
Vitrine fond liège de 5 mm avec encadrement en aluminium anodisé couleur argent, coins arrondis en zamak gris. Portes coulissantes en méthacrylate avec serrure à clé. Idéal pour l'affichage de notes, avis, posters, etc., par épingles et punaises.

**IT** | Bacheca in sughero ad anta scorrevole  
Bacheca in sughero (5 mm.), con profili in alluminio anodizzato ed angoli arrotondati in zamak grigi. Protezione scorrevole in metacrilato con serratura. Ideale per note, avvisi, poster, ecc.

**GB** | Cork surface showcase with sliding doors  
Showcases with cork surface (5 mm.) equipped with silver anodised aluminium frame and grey zamak rounded corners and methacrylat sliding doors. Lockable with key. Ideal for pinning up notes, notices, posters, etc.

**DE** | Korkoberfläche vitrine Mitglasschiebetüren  
Kork-Oberfläche 5 mm. Vitrine mit anodisiertem Aluminiumrahmen, silber eloxiert und abgerundeten grauen Kunststoffecken. Acrylglas-Schiebetüren und Sicherheitsschloss und Sicherheits-Schloss mit Schlüssel.

**PO** | Vitrine de anúncios cortiça  
Vitrine de anúncios com fundo em cortiça de 5 mm., perfil em alumínio anodizado na cor prata mate e cantos arredondados cinzentos, portas de correr em acrílico e fechadura com chave.

A  
T

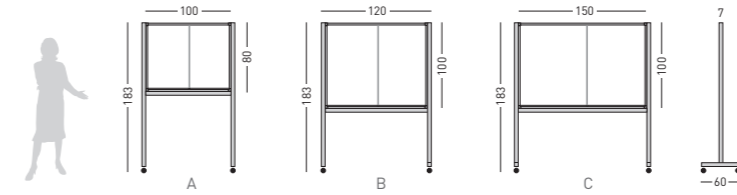

	↕	↔	↔	↔
A 765/V/T2	183	80 x 100	2,5	7
B 765/V/T3	183	100 x 120	2,5	7
C 765/V/T4	183	100 x 150	2,5	7

pg. 34



B  
T

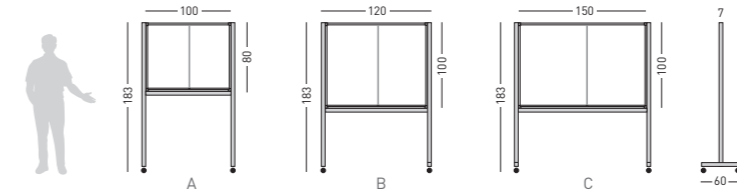

	↕	↔	↔	↔
A 720/V/T2	183	80 x 100	2,5	7
B 720/V/T3	183	100 x 120	2,5	7
C 720/V/T4	183	100 x 150	2,5	7

pg. 34



C  
fluor.

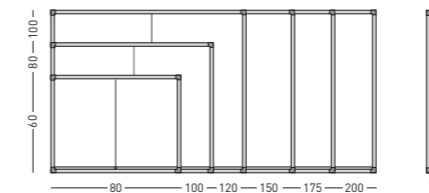

	↕	↔	↔
765/VL1	60 x 80	2,5	7
765/VL2	80 x 100	2,5	7
765/VL3	100 x 120	2,5	7
765/VL4	100 x 150	2,5	7
765/VL5	100 x 175	2,5	7
765/VL6	100 x 200	2,5	7

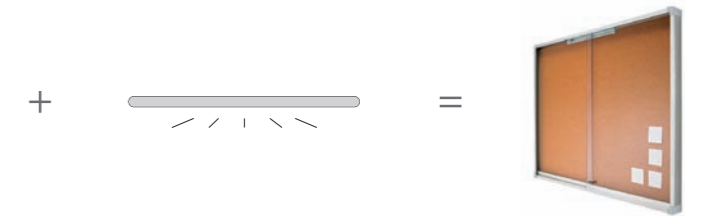

D  
fluor.

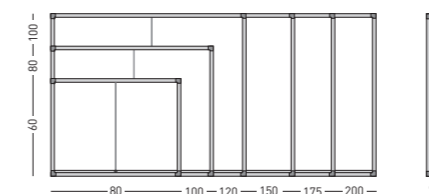

	↕	↔	↔
720/VL1	60 x 80	2,5	7
720/VL2	80 x 100	2,5	7
720/VL3	100 x 120	2,5	7
720/VL4	100 x 150	2,5	7
720/VL5	100 x 175	2,5	7
720/VL6	100 x 200	2,5	7

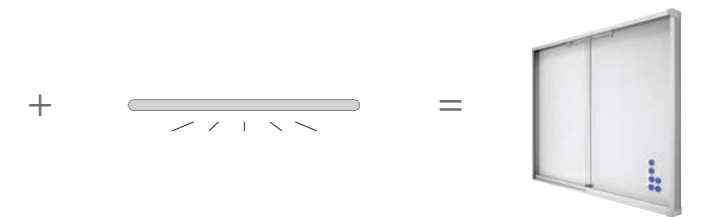



760-V  
PS design



	↑	↔	↔
760/V1	60 x 80	2,5	7
760/V2	80 x 100	2,5	7
760/V3	100 x 120	2,5	7
760/V4	100 x 150	2,5	7
760/V5	100 x 175	2,5	7
760/V6	100 x 200	2,5	7

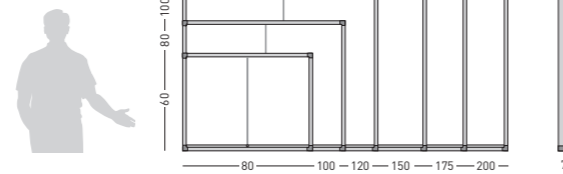

es | Vitrina de corcho tapizada

Vitrina de anuncios mural con fondo de corcho tapizado, marco de aluminio anodizado en color plata mate natural y cantoneras redondeadas de zamak gris, puertas correderas de metacrilato y cerradura con llave.

gb | Felt cork showcase with sliding doors

Showcase with felt cork surface equipped with silver anodised aluminium frame and grey zamak rounded corners, methacrylat sliding doors and lockable. Ideal for pinning up notes, notices, posters, etc.

fr | Vitrine fond liège tissu avec portes

Vitrine fond en liège de 5 mm recouvert de tissu avec encadrement en aluminium anodisé couleur argent, coins arrondis en zamak gris et portes coulissantes en méthacrylate avec serrure. Idéal pour l'affichage de notes, avis, posters, etc..., par épingles et punaises.

de | Vitrine mit textil-Korkoberfläche

Stoffoberfläche Vitrine mit anodisiertem Aluminiumrahmen, silber eloxiert und abgerundeten grauen Kunststoffecken. 2 Acrylglas Schiebetüren. Abschließbar, Sicherheitschloss. Ideal zum Anheften von Photos, Zetteln, Mitteilungen mittels Pinnadeln.

it | Bachecca in feltro ad anta scorrevole

Bachecca in sughero rivestito in tessuto, con profili in alluminio anodizzato ed angoli arrotondati in zamak grigi. Protezione scorrevole in metacrilato con serratura. Ideale per note, avvisi, poster, ecc. Disponibile nei colori nero, bordeaux, blu, verde, grigio, ocra.

po | Vitrine de anúncios forrada

Vitrine de anúncios com fundo em cortiça forrada, perfil em alumínio anodizado na cor prata mate e cantos arredondados cinzentos, portas de correr em acrílico e fechadura com chave.

A  
T

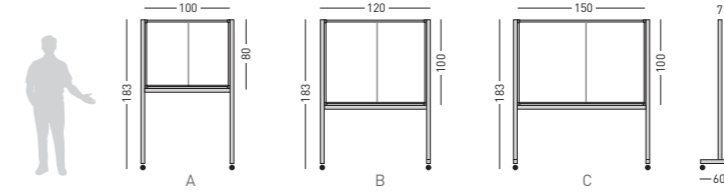

	↑	↔	↔	↔
A 760/V/T2	183	80 x 100	2,5	7
B 760/V/T3	183	100 x 120	2,5	7
C 760/V/T4	183	100 x 150	2,5	7

pg. 34



B  
fluor.

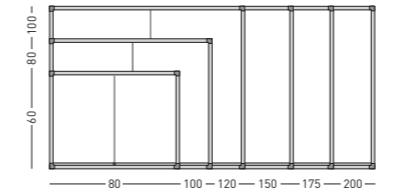

	↑	↔	↔
760/VL1	60 x 80	2,5	7
760/VL2	80 x 100	2,5	7
760/VL3	100 x 120	2,5	7
760/VL4	100 x 150	2,5	7
760/VL5	100 x 175	2,5	7
760/VL6	100 x 200	2,5	7



C  
Kit  
fluor.



	B	↔	↑
FLU/V1	80	4,2	
FLU/V2	100	4,2	
FLU/V3	120	4,2	
FLU/V4	150	4,2	
FLU/V5	175	4,2	
FLU/V6	200	4,2	



X  
acces



7051/S

pg. 101

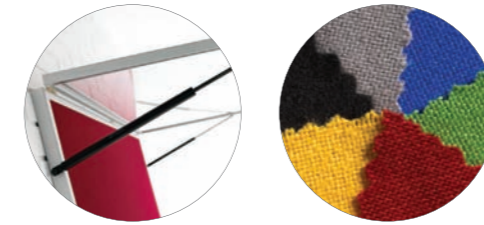
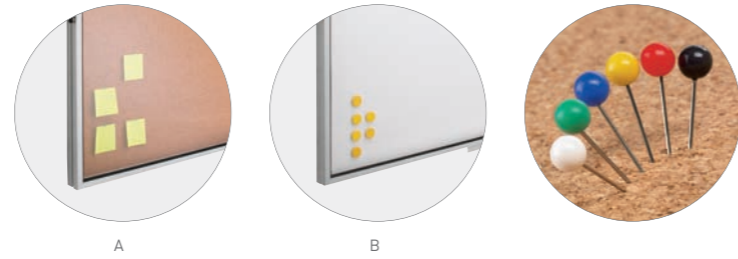

106



107

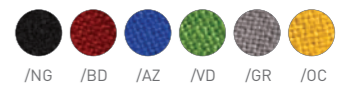

A	↑	←	→	↓
765/VT1	60 x 80	1	4,5	
765/VT2	80 x 100	1	4,5	
765/VT3	100 x 120	1	4,5	

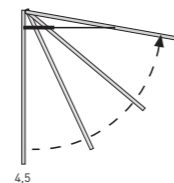
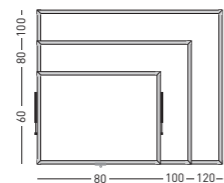

B	↑	←	→	↓
720/VT1	60 x 80	1	4,5	
720/VT2	80 x 100	1	4,5	
720/VT3	100 x 120	1	4,5	

	↑	←	→	↓
760/VT1	60 x 80	1	4,5	
760/VT2	80 x 100	1	4,5	
760/VT3	100 x 120	1	4,5	

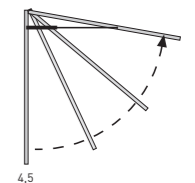
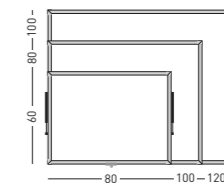

ES | Vitrina con puerta telescópica

Vitrina de anuncios mural con fondo de corcho natural o magnético, marco de aluminio anodizado en color plata mate natural y puerta abatible de metacrilato mediante telescópico y cerradura con llave. Se pueden fijar sobre su superficie notas, avisos, pósters, etc.

FR | Vitrine à l'italienne fond liège

Vitrine à l'italienne fond liège ou magnétique avec encadrement en aluminium anodisé couleur argent naturel. Equipé d'une serrure, porte télescopique en méthacrylate. Idéal pour l'affichage de notes, avis, posters, etc... par épingles et punaises.

IT | Bacheca ad apertura a ribalta

Bacheca in sughero naturale o magnético, con profili in alluminio anodizzato ed angoli arrotondati in plastica grigi. Protezione a ribalta in metacrilato con serratura. Ideale per note, avvisi, poster, ecc.

ES | Vitrina con puerta telescópica

Vitrina de anuncios mural con fondo de corcho natural tapizado, marco de aluminio anodizado en color plata mate natural y puerta abatible de metacrilato mediante telescópico y cerradura con llave. Se pueden fijar sobre su superficie notas, avisos, pósters, etc.

FR | Vitrine à l'italienne fond tissu

Vitrine à l'italienne fond tissu avec encadrement en aluminium anodisé couleur argent naturel. Equipé d'une serrure, porte télescopique en méthacrylate. Idéal pour l'affichage de notes, avis, posters, etc... par épingles et punaises.

IT | Bacheca ad apertura a ribalta

Bacheca in sughero naturale rivestito in tessuto, con profili in alluminio anodizzato ed angoli arrotondati in plastica grigi. Protezione a ribalta in metacrilato con serratura. Ideale per note, avvisi, poster, ecc.

GB | Cork showcase with hinged doors

Showcase with natural cork or felt cork surface equipped with silver anodised aluminium frame and methacrylat hinged doors and lockable. Ideal for pinning up notes, notices, posters, etc. Available in felt cork (6 colours) and mesh (M1).

DE | Pinntafel-rückwand uplift Öffnung vitrine

Vitrine mit anodisiertem Aluminiumrahmen, silber eloxiert und Acrylglas-Aufklappbaretüren. Sicherheitsschloss. Ideal zum Anheften von Photos, Zetteln, Mitteilungen mittels Pinnadeln und Heftzwecke.

PO | Vitrine de anuncios com porta telescópica

Vitrine de anuncios para parede com fundo em cortiça natural ou magnético, aro de alumínio anodizado na cor prata mate, porta telescópica em acrílico e fechadura com chave. Pode-se fixar na sua superfície mensagens, avisos, posters, etc, mediante a utilização de agulhas.

GB | Cork showcase with hinged doors

Showcase with surface equipped with silver anodised aluminium frame and methacrylat hinged doors and lockable. Ideal for pinning up notes, notices, posters, etc. Available in felt cork (6 colours).

DE | Pinntafel-rückwand uplift Öffnung vitrine

Vitrine mit anodisiertem Aluminiumrahmen, silber eloxiert und Acrylglas-Aufklappbaretüren. Sicherheitsschloss. Ideal zum Anheften von Photos, Zetteln, Mitteilungen mittels Pinnadeln und Heftzwecke.

PO | Vitrine de anuncios com porta telescópica

Vitrine de anuncios para parede com fundo em cortiça natural forrado, aro de alumínio anodizado na cor prata mate, porta telescópica em acrílico e fechadura com chave. Pode-se fixar na sua superfície mensagens, avisos, posters, etc, mediante a utilização de agulhas.

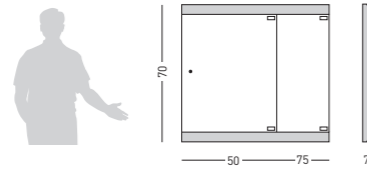
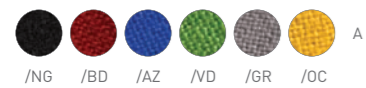
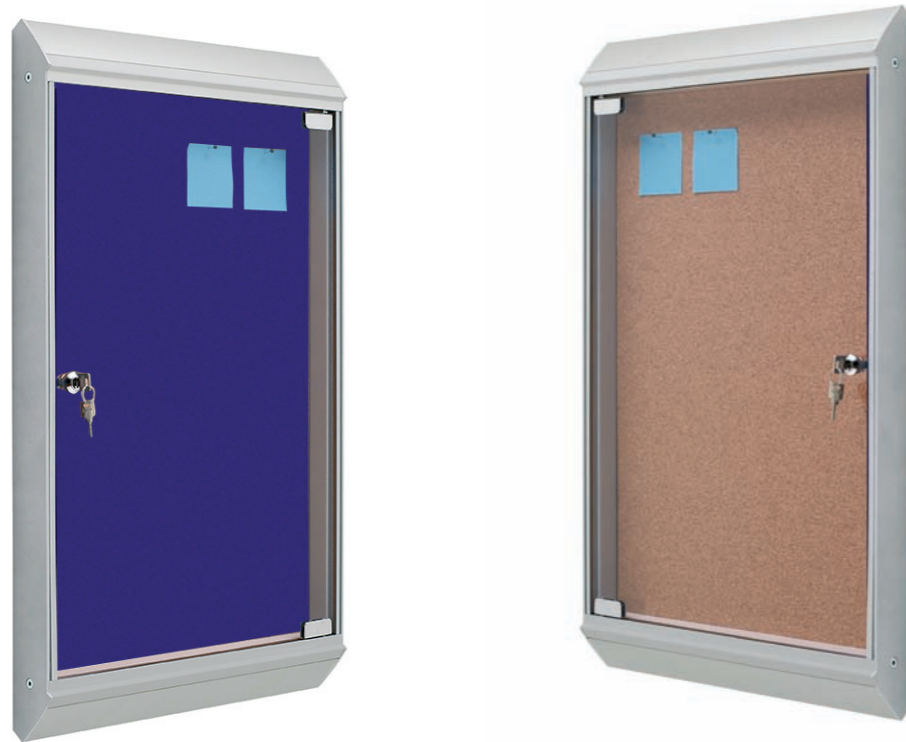
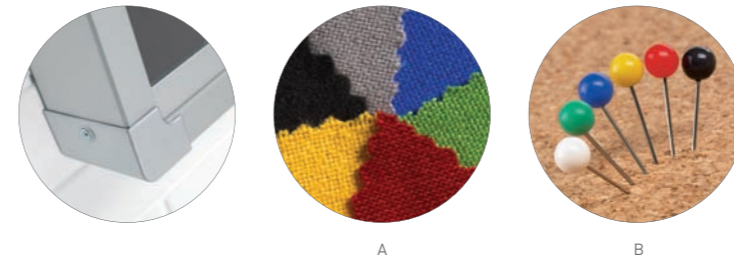

* A	↑	↔	↔
Z/760/NP/2	70 x 50	1,8	3,5
Z/760/NP/3	70 x 75	1,8	3,5

B	↑	↔	↔
Z/765/NP/2	70 x 50	1,8	3,5
Z/765/NP/3	70 x 75	1,8	3,5

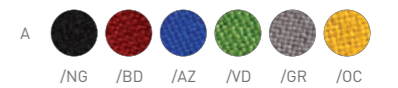
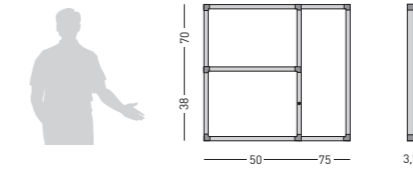

A	↑	↔	↔
760/VP1	38 x 50	1,8	3,5
760/VP2	70 x 50	1,8	3,5
760/VP3	70 x 75	1,8	3,5

B	↑	↔	↔
765/VP1	38 x 50	1,8	3,5
765/VP2	70 x 50	1,8	3,5
765/VP3	70 x 75	1,8	3,5

ES | Vitrina "Zénit" con puerta abatible

Vitrina de anuncios mural Zénit enmarcada con perfil de aluminio anodizado en color plata mate (tapa personalizable). Puertas abatibles de metacrilato y cerradura con llave. Superficie de corcho natural o tapizado en colores.

FR | Vitrine "Zénit" porte battante

Vitrine d'information murale avec encadrement en aluminium anodisé (personnalisable). Portes battantes en méthacrylate et serrure avec clé. Surface liège + tissu.

IT | Vetrina "Zénit" apertura a libro

Bacheca per annunci da parete Zénit con cornice di alluminio anodizzato colore argento opaco (personalizzabile). Protezione a libro in metacrilato conserratura. Ideale per note, avvisi, poster, ecc.

ES | Vitrina de corcho con puerta abatible

Vitrina de anuncios mural con fondo tapizado o corcho natural, marco de aluminio anodizado en color plata mate natural y cantoneras redondeadas de zamak gris, puerta abatible de metacrilato y cerradura con llave. Se puede fijar: notas, avisos,...

FR | Vitrine à porte battante

Vitrine à porte battante fond liège avec encadrement en aluminium anodisé couleur argent naturel et coins arrondis en zamak gris. Équipée d'une serrure porte en méthacrylate. Idéal pour l'affichage de notes, avis, posters, etc... par épingles et punaises.

IT | Bacheca ad apertura a libro

Bacheca in sughero con feltro, con profili in alluminio anodizzato ed angoli arrotondati in zamak grigi. Protezione a libro in metacrilato conserratura. Ideale per note, avvisi, poster, ecc. Disponibile nei colori nero, bordeaux, blu, verde, grigio, ocra.

GB | Showcase "Zénit" with swing door

Wall showcase cork surface or cork+fabric, with anodized aluminium frame (customizable). Methacrylate swing doors with key.

DE | Vitrine "Zénit" mit Schloss und Schlüssel

Vitrine mit anodisiertem Aluminiumrahmen, matt-silber. Acrylglastüren mit Schloss und Schlüssel. Oberfläche aus natürlichem Kork oder mit Stoff tapiziert.

PO | Vitrine "Zénit" com porta abatível

Vitrine de anúncios de parede Zénit com perfil em alumínio anodizado na cor prata mate (personalizável). Porta abatível em acrílico e fechadura com chave. Superfície em cortiça natural ou forrada com cores.

GB | Showcase with swing door

Showcases with cork surface equipped with silver anodised aluminium frame and grey zamak rounded corners and swing doors. Lockable. Ideal for pinning up notes, notices, posters, etc.

DE | Flügeltür vitrine

Korkoberfläche Vitrine mit anodisiertem Aluminiumrahmen, silber eloxiert und abgerundeten grauen Kunststoffecken. 2 Acrylglas-Flügeltüren. Ideal zum Anheften von Photos, Zetteln, Mitteilungen mittels Pinnadeln und Heftzwecke.

PO | Vitrine de anuncios com porta abatível

Vitrine de anuncios para parede com fundo em cortiça, aro de alumínio anodizado na cor prata mate e cantos arredondados de zamak cinzento. Porta abatível de acrílico e fechadura com chave. Pode-se fixar na sua superfície mensagens, avisos, posters, etc.



110



* A	↑	↖	↗	↔
Z/765/V1	55 x 75	70 x 80	7	
Z/765/V2	75 x 95	90 x 100	7	
Z/765/V3	95 x 115	110 x 120	7	
Z/765/V4	95 x 145	110 x 150	7	
Z/765/V5	95 x 170	110 x 175	7	
Z/765/V6	95 x 195	110 x 200	7	

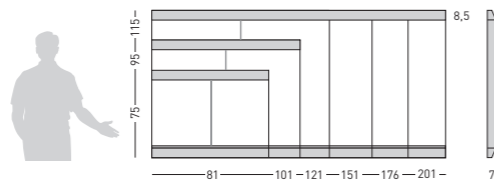

B	↑	↖	↗	↔
Z/720/V1	55 x 75	70 x 80	7	
Z/720/V2	75 x 95	90 x 100	7	
Z/720/V3	95 x 115	110 x 120	7	
Z/720/V4	95 x 145	110 x 150	7	
Z/720/V5	95 x 170	110 x 175	7	
Z/720/V6	95 x 195	110 x 200	7	

es | Vitrina "Zénit" de corcho natural

Vitrina de anuncios mural Zénit enmarcada con perfil de aluminio anodizado en color plata mate (personalizable). Puertas correderas de metacrilato y cerradura con llave. Superficie de corcho natural o blanca magnética de acero vitrificado.

fr | Vitrine "Zénit" fond liège

Vitrine fond liège naturel de 5 mm avec encadrement en aluminium anodisé (personnalisable). Portes coulissantes en méthacrylate avec serrure. Idéal pour l'affichage de notes, avis, posters, etc... par épingles et punaises.

it | Bacheca "Zénit" sfondo in sughero

Bacheca per annunci da parete Zénit con cornice di alluminio anodizzato colore argento opaco (personalizzabile). Porte scorrevoli di metacrilato e serratura con chiave. Superficie in sughero naturale.

gb | Showcase "Zénit" cork

Showcase with cork 5 mm and anodized aluminium frame (customizable). Methacrylate secured sliding doors with key. Ideal for pinning up notes, notices, posters, etc.

de | Vitrine "Zénit" mit Naturkorkoberfläche

Vitrine mit Naturkorkoberfläche, mattsilbernen anodisiertem Aluminiumrahmen, silber eloxiert und abgerundeten Kunststoffecken. Zwei Acrylglaschiebetüren mit Sicherheitsschloss. Die Oberfläche ist aus natürlichem Kork.

po | Vitrine "Zénit" em cortiça natural

Vitrine de anúncios de parede Zénit com perfil em alumínio anodizado na cor prata mate (personalizável). Portas de correr em acrílico e fechadura com chave. Superfície em cortiça natural.

A  
Y2

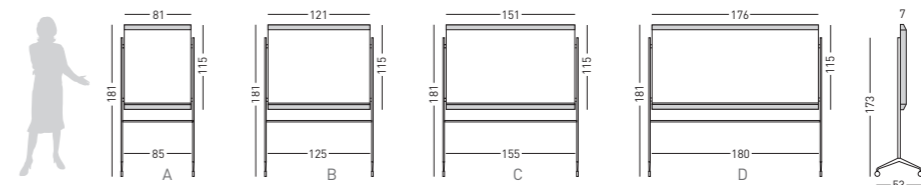

	↑	↖	↗	↔
A Z/765/NY2	181	75 x 95	90 x 100	7
B Z/765/NY3	181	95 x 115	110 x 120	7
C Z/765/NY4	181	95 x 145	110 x 150	7
D Z/765/NY5	181	95 x 170	110 x 175	7

pg. 34



B  
Y2

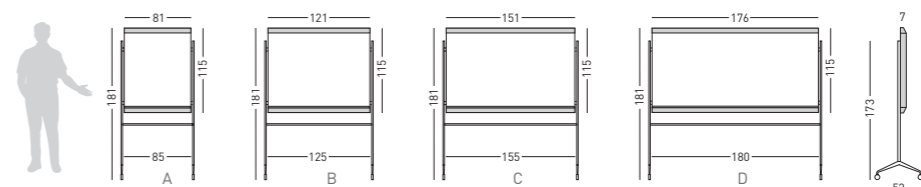

	↑	↖	↗	↔
A Z/720/NY2	181	75 x 95	90 x 100	7
B Z/720/NY3	181	95 x 115	110 x 120	7
C Z/720/NY4	181	95 x 145	110 x 150	7
D Z/720/NY5	181	95 x 170	110 x 175	7

pg. 34



111

C  
fluor.

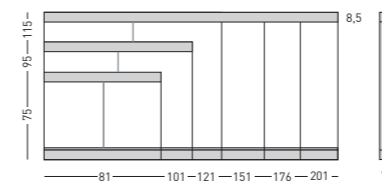

	↑	↖	↗	↔
Z/765/VL1	55 x 75	70 x 80	7	
Z/765/VL2	75 x 95	90 x 100	7	
Z/765/VL3	95 x 115	110 x 120	7	
Z/765/VL4	95 x 145	110 x 150	7	
Z/765/VL5	95 x 170	110 x 175	7	
Z/765/VL6	95 x 195	110 x 200	7	



D  
fluor.

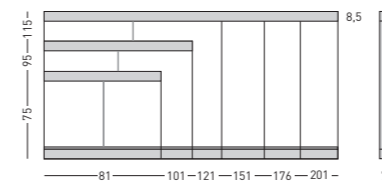

	↑	↖	↗	↔
Z/720/VL1	55 x 75	70 x 80	7	
Z/720/VL2	75 x 95	90 x 100	7	
Z/720/VL3	95 x 115	110 x 120	7	
Z/720/VL4	95 x 145	110 x 150	7	
Z/720/VL5	95 x 170	110 x 175	7	
Z/720/VL6	95 x 195	110 x 200	7	



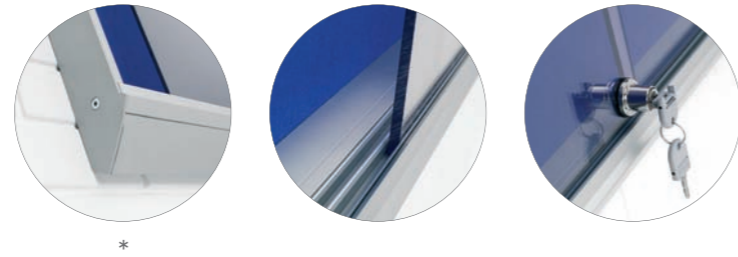

*	↑	↖	↗
Z/760/V1	55 x 75	70 x 80	7
Z/760/V2	75 x 95	90 x 100	7
Z/760/V3	95 x 115	110 x 120	7
Z/760/V4	95 x 145	110 x 150	7
Z/760/V5	95 x 170	110 x 175	7
Z/760/V6	95 x 195	110 x 200	7

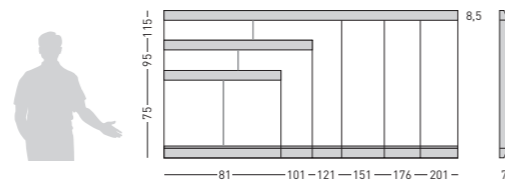

**ES** | Vitrina "Zénit" de corcho tapizado  
Vitrina de anuncios Zénit enmarcada con perfil de aluminio anodizado en color plata mate (tapa personalizable). Puertas correderas de metacrilato y cerradura con llave. Superficie de corcho tapizada en color.

**FR** | Vitrine "Zénit" fond liège + tissu  
Vitrine d'affichage avec fond liège + tissu (6 couleurs disponibles) et encadrement en aluminium anodisé (personnalisable). Portes coulissantes en méthacrylate avec serrure. Idéal pour l'affichage de notes, avis, posters, etc., par épingles et punaises.

**IT** | Bacheca rivestita "Zénit" cornice  
Bacheca per annunci da parete Zénit con cornice di alluminio anodizzato colore argento opaco (personalizzabile). Porte scorrevoli di metacrilato e serratura con chiave. Superficie in sughero ricoperta da colori.

**GB** | Showcase "Zénit" cork  
Showcase with cork + colored fabric (6 colors) and anodized aluminium frame (customizable). Methacrylat secured sliding doors with key. Ideal for pinning up notes, notices, posters, etc.

**DE** | Vitrine "Zénit" mit Textiloberfläche  
Vitrine mit Textilkorktafel, mattsilbernen anodisiertem Aluminiumrahmen, silber eloxiert und abgerundeten Kunststoffecken. Zwei Acrylglaschiebetüren mit Sicherheitsschloss.

**PO** | Vitrine "Zénit" forrada  
Vitrine de anúncios de parede Zénit com perfil em alumínio anodizado na cor prata mate (personalizável). Portas de correr em acrílico e fechadura com chave. Superfície em cortiça forrada com cores.

A  
Y2

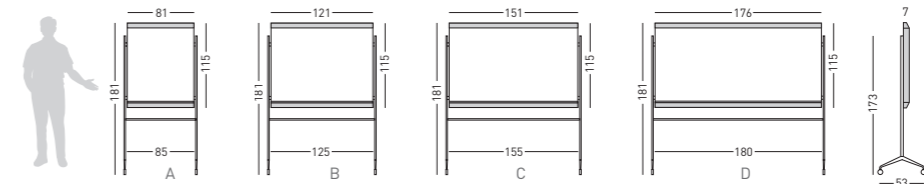

	↑	↖	↗	↔
A Z/760/Y2	181	75 x 95	90 x 100	7
B Z/760/Y3	181	95 x 115	110 x 120	7
C Z/760/Y4	181	95 x 145	110 x 150	7
D Z/760/Y5	181	95 x 170	110 x 175	7

pg. 34



B  
fluor.



A	↑	↖	↗
Z/760/VL1	55 x 75	70 x 80	7
Z/760/VL2	75 x 95	90 x 100	7
Z/760/VL3	95 x 115	110 x 120	7
Z/760/VL4	95 x 145	110 x 150	7
Z/760/VL5	95 x 170	110 x 175	7
Z/760/VL6	95 x 195	110 x 200	7



X  
acces



7051/S

pg. 101

# CORK SHOWCASE



\* Set de pins incluido.  
\* Set pins included.

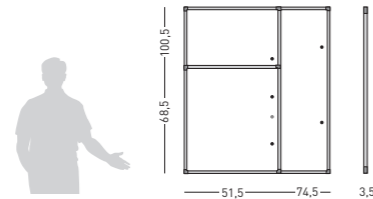

BL/IN/0150	51,5 x 68,5	3,5
BL/IN/0151	51,5 x 100,5	3,5
BL/IN/0152	74,5 x 100,5	3,5

## ES | Vitrina Basic Line corcho

Vitrina de anuncios de corcho natural para uso interior fabricadas con perfil de aluminio anodizado mate y cantoneras redondeadas grises. Provistas de cerradura con llave. Incluye set de pins.

## GB | Cork Showcase Basic Line

Natural cork for inside use showcase made with mat anodised aluminium profile and rounded grey plastic corners. Include a lock with key and a set of magnet.

## FR | Vitrines Basic liège

Vitrines en liège naturel pour un usage intérieur en profilé d'aluminium anodisé et coins arrondis gris mat. Equipé avec serrure à clé et avec des punaises.

## DE | Vitrine mit Naturkorkpinnwand

Vitrine mit Naturkorkpinnwand für den Innenbereich, hergestellt anodisiertem Aluminiumrahmen, matt und mit grauen, abgerundeten Kunststoffecken. Abschliessbar, mit einem Set von Pins.

## IT | Bachecca Basic Line sughero

Bachecca per comunicazioni in sughero naturale per uso da interni, realizzata in profilo di alluminio anodizzato opaco e profili angolari grigi. Provista di serratura con chiave. Set di puntine incluso.

## PO | Vitrine Basic Line em cortiça

Vitrine de anúncios em cortiça para utilização em interior, fabricada com perfil de alumínio prata mate e cantos arredondos cinzentos. Inclui fechadura com chave e conjunto de pioneses.



# MAGNET SHOWCASE



\* Set de imanes incluido.  
\* Set magnets included.

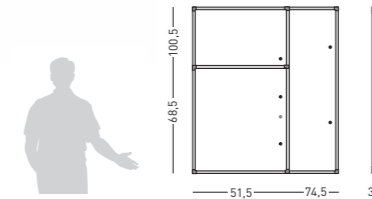

BL/IN/0110	51,5 x 68,5	3,5
BL/IN/0111	51,5 x 100,5	3,5
BL/IN/0112	74,5 x 100,5	3,5

## ES | Vitrina Basic Line magnética

Vitrina de anuncios magnética para uso interior fabricadas con perfil de aluminio anodizado mate y cantoneras redondeadas grises. Provistas de cerradura con llave. Incluye set de imanes.

## GB | Magnetic Showcase Basic Line

Magnetic for inside use showcase made with mat anodised aluminium profile and rounded grey plastic corners. Include a lock with key and a set of magnet.

## FR | Vitrines Basic magnétique

Vitrines d'affichage magnétique en aluminium anodisé avec intérieur gris mat et coins arrondis conçu pour être utilisé en intérieur. Equipé avec serrure à clé et un jeu d'aimants.

## DE | Vitrine mit Magnettafel

Vitrine mit Magnettafel, für den Innenbereich, hergestellt anodisiertem Aluminiumrahmen, matt und mit grauen, abgerundeten Kunststoffecken. Abschliessbar, mit einem Set von Magneten.

## IT | Bachecca Basic Line magnetica

Bachecca di comunicazione magnetica ed uso per interni realizzata con profilo di alluminio anodizzato opaco e raccordi angolari arrotondati grigi. dotata di serratura con chiave. Include gruppo di magneti.

## PO | Vitrine Basic Line magnética

Vitrine de anúncios magnética para utilização em interior, fabricada com perfil de alumínio prata mate e cantos arredondos cinzentos. Inclui fechadura com chave e conjunto de imanes.

# 767-VE



	↙	↔	A4
767/VE/1	40 x 55	3	2
767/VE/2	75 x 55	3	4
767/VE/3	75 x 75	3	6
767/VE/4	105 x 75	3	9

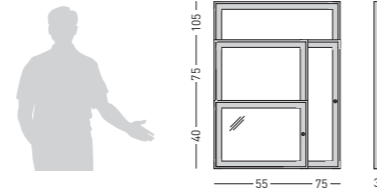

## A support

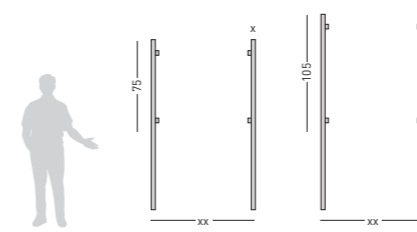

767/SOP	↙	↔	A4
	75 x 75	3	2

es | Juego de soportes de aluminio para vitrinas de la gama 767 de exterior.  
 es | Aluminium supports for 767 outdoor showcases range.  
 fr | Jeux de piétement en aluminium pour les vitrines d'extérieur de la gamme 767.  
 de | Set von Halterung aus Aluminium für Vitrinen der Reihe 767, Aussenbereich.  
 it | Gruppo di supporti di alluminio per bacheche della gamma 767 da esterno  
 po | Conjunto de suportes em alumínio para vitrinas da gama 767 de exterior.

out  
door

## 767 school

	↙	↔	↔	A4
A 767/MA	68 x 73	40 x 55	3	2
B 767/CO	92 x 81	40 x 55	3	2
C 767/OS	75 x 103	75 x 55	3	4
D 767/PI	90 x 112	75 x 55	3	4
E 767/BU	100 x 140	75 x 75	3	6
F 767/TO	126 x 108	75 x 75	3	6

\* LED optional



pg. 120 - 121

### es | Vitrina mural para exterior

Vitrina de anuncios mural con marco de aluminio anodizado en color plata mate natural, puerta de policarbonato y cerradura con llave. Fondo con base magnética blanca. Estancas a la lluvia y permiten su colocación a la intemperie.

### fr | Vitrine d'extérieur

Vitrine d'extérieur fond tableau blanc magnétique avec encadrement en aluminium anodisé couleur argent naturel. Porte en polycarbonate avec serrure. Très résistante aux intempéries et étanche.

### it | Bachecca a muro per esterno

Bachecca con cornice in alluminio anodizzato naturale e protezione in policarbonato. Chiusura di sicurezza. Superficie bianca magnetica compatibile con accessori magnetici. Resistente all'acqua.

### es | Outdoor wall showcase

Showcase equipped with silver anodised aluminium and polycarbonate door. Safety lock. Magnet attachable whiteboard surface compatible with magnetic accessories. Water and weatherproof.

### de | Vitrine für Außen

Vitrine mit anodisiertem Aluminiumrahmen, silber eloxiert 30 mm, Acrylglas-Schiebetüren. Sicherheits-Schloss. Magnethantende weiße Rückwand. Ideal für Magnete. Wasserund Wetterfest.

### po | Vitrine de parede para exterior

Vitrine de anúncios para parede com aro de alumínio anodizado na cor prata mate natural. Porta em policarbonato e fechadura. Fundo magnético branco para a utilização de magnéticos. Resistente á chuva.

## X acces



pg. 101



	↕	↔	A4
768/VE/1	100 x 135	7,5	15
768/VE/2	100 x 160	7,5	21
768/VE/3	100 x 201	7,5	27

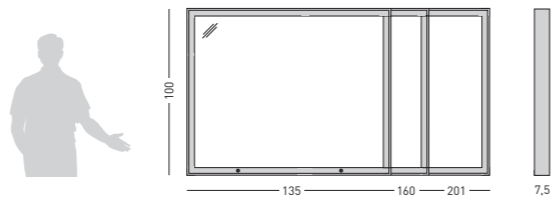

A  
soporte

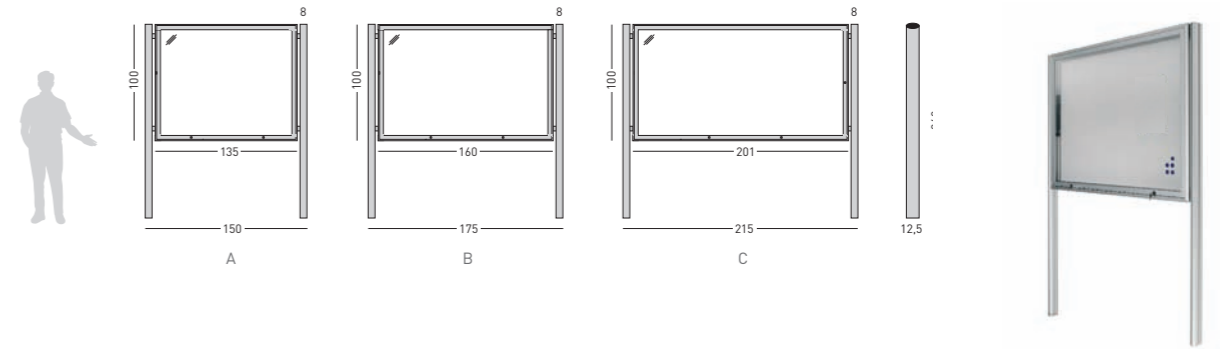

	↕	↔	A4
A 768/VEP/1	100 x 135	7,5	15
B 768/VEP/2	100 x 160	7,5	21
C 768/VEP/3	100 x 201	7,5	27



B  
soporte  
fluor.

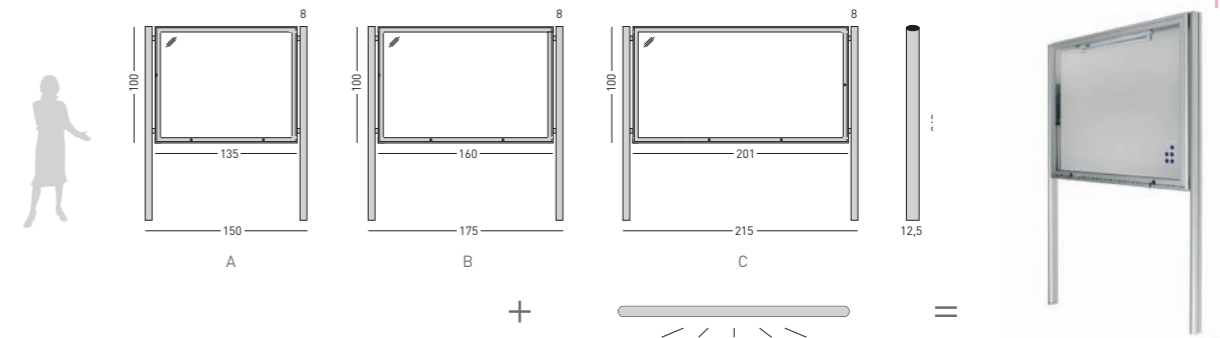

	↕	↔	A4
A 768/VEP/L1	100 x 135	7,5	15
B 768/VEP/L2	100 x 160	7,5	21
C 768/VEP/L3	100 x 201	7,5	27



C  
fluor.



	↕	↔	A4
768/VE/L1	100 x 135	7,5	15
768/VE/L2	100 x 160	7,5	21
768/VE/L3	100 x 201	7,5	27



ES | Vitrina mural para exterior "Top"

Vitrinas de anuncios murales con marco de aluminio anodizado en color plata mate natural. Puerta abatible telescópica de policarbonato y doble cerradura con llave. Fondo magnético blanco. Estancas a la lluvia y permiten su colocación a la intemperie.

FR | Vitrine d'extérieur "Top"

Vitrine d'extérieur fond tableau blanc magnétique avec encadrement en aluminium anodisé argent naturel. Porte à l'italienne en polycarbonate et double serrure avec clef. Résistants aux intempéries et étanche.

IT | Bachecca a muro per esterno "Top"

Bachecca con cornice in alluminio anodizzato naturale con o senza illuminazione. Protezione in policarbonato con chiusura a ribalta e doppia chiusura di sicurezza. Superficie magnetica bianca. Ideale per accessori magnetici. Resistente all'acqua.

GB | Outdoor wall showcase "Top"

Showcase equipped with silver anodised aluminium frame with or without light. Polycarbonate door with hinges and double safety lock with key. Magnetic whiteboard surface. Ideal for pinning up magnetic accessories. Water and weatherproof.

DE | Vitrine Für Außen "Top"

Vitrine mit anodisiertem Aluminiumrahmen, silber eloxiert Acrylglas-Aufklappbaretüren. Doppelsicherheitsschloss mit Schlüssel. Magnethantende weiße Rückwand. Ideal für Magnete. Wasser- und Wetterfest.

PO | Vitrine de parede para exterior "Top"

Vitrine de anúncios para parede com aro de alumínio anodizado na cor prata mate natural. Porta em policarbonato e fechadura. Fundo magnético branco para a utilização de magnéticos. Resistente à chuva.

X  
acces





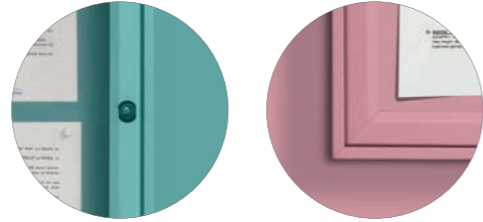

	↖	↗	↔	A4
767/MA	68 x 73	40 x 55	3	2
767/CO	92 x 81	40 x 55	3	2
767/OS	75 x 103	75 x 55	3	4
767/PI	90 x 112	75 x 55	3	4
767/BU	100 x 140	75 x 75	3	6
767/TO	126 x 108	75 x 75	3	6

\* LED optional

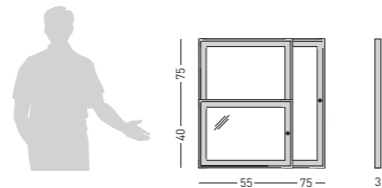

ES | Vitrinas animadas

Gama de vitrinas preparadas para exterior fabricadas con perfil de aluminio pintado de color y dotadas con cerradura. La vitrina va montada sobre una chapa pintada del mismo color con forma de animal. Disponibles para: 2, A2 conejo y mariposa, 4, A4 oso y pingüino, y 6, A4 Buho y Tortuga.

GB | Animated showcases

Range of showcases made for outside use, made of painted aluminium and with a lock. The showcase is mounted on a painted plate of same colour and with shape of an animal. For 2 times A4 doc; Rabbit and Butterfly, 4 x A4 Bear and Penguin and 6 x A4 Owl and Turtle.

FR | Vitrines animées

Gamme de vitrines d'affichages pour l'extérieures faites en aluminium peint et équipées de serrures. La vitrine est montée sur une plaque peinte de la même couleur et avec formes d'animaux. Disponible pour: 2 x A2 lapin et papillon, 4 x A4 ours et pingouin, et 6 x A4 hibou et Tortue.

DE | Animierte Vitrinen

Sortiment von Vitrinen für den Aussenbereich, hergestellt aus Aluminium, lackiert und abschliessbar. Die Vitrine wird auf einem gleichfarbigem Halblech in Form eines Tieres montiert. Verfügbar: 2, A2 Kanninchen und Schmetterling; 4, A4 Bär und Pinguin; 6, A4 Eule und Schildkröte.

IT | Vetrine animate

Collezione di bacheche per uso esterno realizzate con struttura in alluminio verniciato colorato con serratura. La bacheca è montata su una placca zooloforme.

PO | Vitrines animadas

Gama de vitrines preparadas para colocação no exterior, fabricadas com perfil em alumínio pintado e com fechadura. A vitrina é montada sobre uma chapa pintada da mesma cor do alumínio e com forma de animal. Disponíveis para: 2xA2 coelho e borboleta, 4xA4 urso e pinguim, e 6xA4 mocho e tartaruga.

A  
2 A4

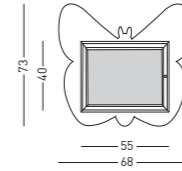

	↖	↗	↔	A4
767/MA	68 x 73	40 x 55	3	2

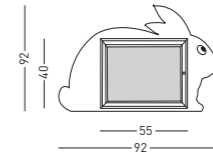

	↖	↗	↔	A4
767/CO	92 x 81	40 x 55	3	2

B  
4 A4

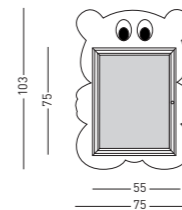

	↖	↗	↔	A4
767/OS	75 x 103	75 x 55	3	4

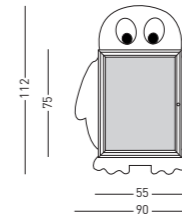

	↖	↗	↔	A4
767/PI	90 x 112	75 x 55	3	4

C  
6 A4

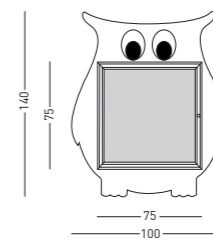

	↖	↗	↔	A4
767/BU	100 x 140	75 x 75	3	6

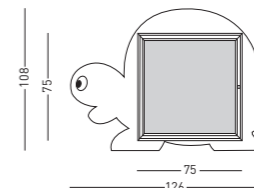

	↖	↗	↔	A4
767/TO	126 x 108	75 x 75	3	6

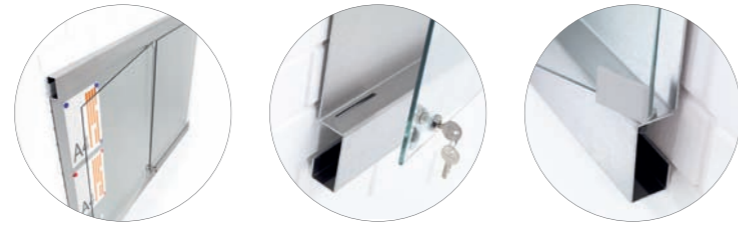

122

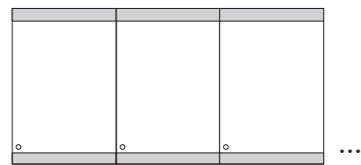
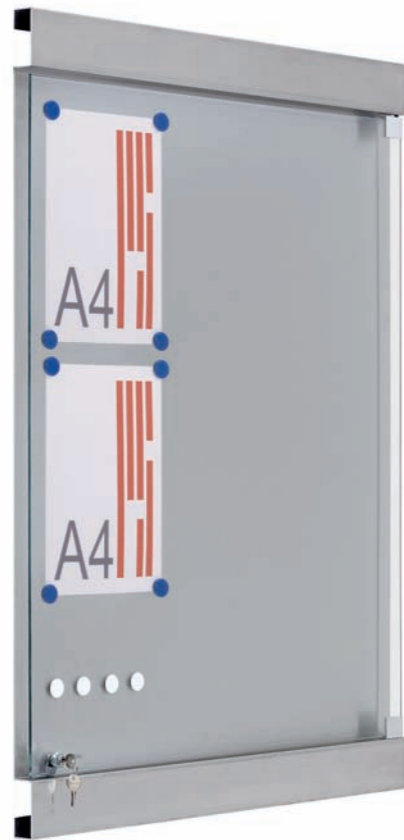

	↑	→	⊠
763/1	54 x 32	3	2
763/2	75 x 55	3	4
763/3	105 x 73	3	9

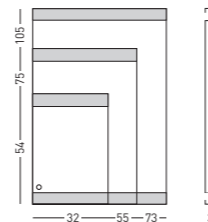

ES | Vitrina de chapa "Delhi"

Vitrina mural de chapa acero inoxidable para interior de gran diseño y estética. Fondo magnético para adaptar imanes y cristal abatible con cerradura y llave. Las vitrinas pueden adosarse una al lado de la otra formando un gran mural de la medida deseada.

68 | Metal sheet "Delhi" Showcase for inner

Showcase made of stainless steel metal sheet and for inner design. Magnetic surface to place magnets and a snapframe glass lockable with key. The showcases can be linked together shaping a wall composition.

FR | Vitrine "Delhi"

Vitrine d'intérieur en acier inoxydable, au design innovant et esthétique. Fond magnétique pour aimants avec porte battante en verre munie d'une serrure à clé. Les vitrines peuvent être mises les unes à côté des autres pour former une seule et grande vitrine.

DE | Vitrine aus Blech für Innen "Delhi"

Vitrine aus rostfreiem Stahl-Blech für Innen. Designvoll und ästhetisch. Magnethaftende Rückwände, ideal für Magnete und Flügelglass mit Sicherheitschloß und Schlüssel. Die Vitrinen können aneinander angehängt werden, um eine große Wand zu bilden.

IT | Foglio metallico "Delhi"

Foglio metallico "Delhi" per bacheca da interno fatto in acciaio inox. Superficie magnetica per mettere magnetini e chiusura a scatto in vetri con chiave. Le bacheche possono essere unite creando una composizione a muro.

PO | Vitrine "Delhi"

Vitrine em chapa de aço inoxidável para interior de grande design e estética. Fundo magnético para adaptar magnéticos e vidro abatível com fechadura e chave. As vitrines podem colocar-se lado a lado, formando um conjunto na medida desejada.

123

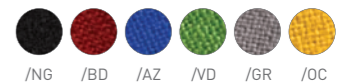

A	↑	→	⊠
726/01	60 x 80	2,3	30
726/02	80 x 100	2,3	30
726/03	100 x 120	2,3	30
726/04	100 x 150	2,3	30

\* Pizarra + tablero de corcho  
\* Board + cork board

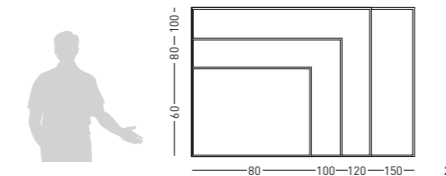

B	↑	→	⊠
726/11	60 x 80	2,3	30
726/12	80 x 100	2,3	30
726/13	100 x 120	2,3	30
726/14	100 x 150	2,3	30

\* Pizarra + tablero tapizado  
\* Board + felt board

ES | Combi boards

Combi board mitad Pizarra mural blanca lacada, mitad tablero de corcho enmarcado con perfil de aluminio anodizado en color plata mate y cantoneras redondeadas de plástico gris. Permite rotular en seco y uso de chinchetas. Incorpora cajetín de 30cms.

68 | Combi boards

Combi board divided in 2 surfaces, one lacquered the other in natural cork with silver anodised framed with and plastic rounded corners. To use with dry pen marker and pinning up notes. A 30 cm pen tray is included.

FR | Combi tableau/liège

Tableau combi avec moitié laqué magnétique blanc et l'autre en liège, avec cadre en aluminium anodisé de couleur argent mat et coins arrondis en plastic gris. Pour feutres effaçables à sec et pour les punaises. Comprend un auget de 30 cm.

DE | Combi Board

Combi Board, halb Weisse Wandtafel, halb Korktafel, anodisierter Aluminiumrahmen, silbereloxiert, mit abgerundeten Kunststoffecken. Zum Gebrauch von trocken abwischbaren Markern und Reisszwecken. Stiftablage von 30cm.

IT | Combinato lavagna/sughero

Combinato metà lavagna da muro laccata bianca, metà bacheca in sughero con profilo in alluminio anodizzato in colore argento opaco e raccordi angolari arrotondati in plastica grigio. Permette di scrivere a secco o utilizzare puntine da disegno. Incorpora pannellino di 30 cm.

PO | Comboard quadro/cortiça

Combi Board metade Quadro branco de parede lacada, metade quadro de cortiça com perfil em alumínio anodizado na cor prata mate e cantos redondos em plástico cinzento. Permite a utilização de marcadores e de pineses. Inclui um suporte com 30 cm.