

05 Modulplan

ES| Mobiliario auxiliar
GB| Auxiliar furniture
FR| Mobilier auxiliaire
DE| Beisellmöbel
IT| Mobili ausiliari
PO| Mobiliário auxiliar



es| Mobiliario auxiliar
La familia MODULPLAN se compone de una gran gama de productos de mobiliario auxiliar dirigidos principalmente a la empresa. Mamparas modulares fijas y flexibles, estanterías, percheros, papeleras, atriles, armarios auxiliares y de audiovisuales, mesas modulares y alfombras protectoras de suelo hacen de esta gama de artículos un accesorio primordial para la oficina. El actual diseño y las múltiples posibilidades, hacen junto a la gama cromática, que sea el accesorio ideal para su oficina...



FR| Mobilier auxiliaire
ModulPlan est une famille de produit de mobilier auxiliaire pour le bureau et les entreprises. Les cloisons modulables et de séparation d'espace, portes manteaux, corbeilles à papier, armoires auxiliaires et audio visuelles, chevalets de conférence, étagères, tapis de sols pour les fauteuils à roulettes... sont des produits indispensables dans un bureau. Le design et les multiples possibilités de cette gamme chromatique font de ses produits des accessoires incontournables du bureau.



IT| Mobili ausiliari
La famiglia MODULPLAN è composta da un'ampia gamma di complementi di arredo diretti principalmente ad aziende ed uffici. Questa gamma di prodotti è ideale per uffici grazie al suo design ed alle molteplici possibilità. Strutture fisse e modulari, mensole, appendiere, cestini, tavoli per conferenze, armadietti ausiliari e per audio-visuale, tavoli modulari e tappetini per protezione di pavimenti sono accessori indispensabili per ogni ufficio.



GB| Auxiliar furniture
The MODULPLAN family is composed of a broad range of auxiliary furniture directed mainly to companies and offices. This range of products is ideal for offices thanks to its design and multiple possibilities. The fixed and modular boards, shelves, coat hangers, wastepaper bins, conference desks, auxiliary and audiovisual cabinets, modular tables and protection floor carpets are indispensable accessories for offices.



DE| Beistellmöbel
MODULPLAN Familie enthält eine grosse Palette von Möbelprodukten, die hauptsächlich an die Büros gerichtet sind. Feste und flexible modulare Fächer, Regale, Papiersortierfächer, Rednerpulte, audiovisuelle Mand-schränke, modulare Beistellwagen, Moderatoren tafeln, Garderobenständer und Schutzmatte geben diesen Artikeln eine wesentliche Rolle im Büro. Das Fashion Design, die vielseitige Verwendbarkeit der Produkte und die chromatische Palette sind die Schlüsselfaktoren.



PO| Mobiliário auxiliar
A família MODULPLAN é composta por uma grande gama de produtos de mobiliário auxiliar dirigidos principalmente às empresas. Biombo modulares fixos e flexíveis, estantes, cabides, papeleras, púlpitos, armários auxiliares e de audiovisuais, mesas modulares e tapetes protectores de chão fazem desta gama de artigos um dos acessórios principais para o escritório. O actual desenho e as múltiplas possibilidades, fazem junto com a gama de cores, com que seja o acessório ideal para a sua empresa.





* Ref. Standard
RAL: 7035

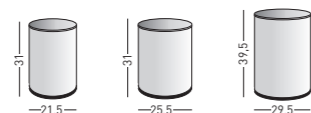
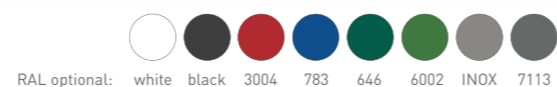

	↑	↔	L
A 6001	31	21,5	12
B 6002	31	25,5	16
C 6003	39,5	29,5	27

ES | Papelera basic 6000

Gama de papeleras metálicas lisas pintadas epoxi, provistas de aro inferior de PVC. Disponibles en 12, 16 y 27 litros. Color standard gris RAL 7035. Bajo pedido ver gama de colores.

FR | Corbeilles Basic 6000

Gamme de corbeille à papier en métal époxy peint, équipé d'un anneau inférieure en PVC. Disponible en 12, 16 et 27 litres. Couleur standard gris RAL 7035. Consultez nous pour un coloris spécial.

IT | Gettacarte Basic

Damma di gettacarte metallici lisci verniciati epossidici, base in PVC. Disponibile in 12, 16, 27 litri. Colore standard RAL 7035. Su richiesta vedere gamma di colori.

GB | Basic bins 6000

Smooth metal wastebaskets Range epoxy painted, fitted with PVC bottom ring. Available in 12, 16 and 27 liters. Standard colour gray RAL 7035. Ask us for a special colour.

DE | Sortiment von Metallpapierkörben

Sortiment von Metallpapierkörben, epoxidlackiert, innerer Ring aus PVC. Erhältlich in 12, 16 und 27 Ltr. Standardfarbe grau RAL 7035. Auf Bestellung sind andere Farben möglich.

PO | Papeleiras Basic 6000

Gama de papeleiras metálicas lisas pintadas epoxi, com aro inferior em PVC. Disponíveis em 12, 16 e 27 litros. Cor standard cinzento RAL 7035. Por pedido podem ser pintadas de acordo com uma gama de cores.



* Ref. Standard
RAL: 7035

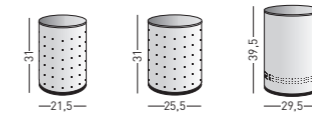
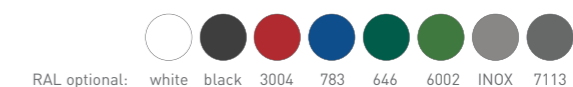

	↑	↔	L
D 6006	31	21,5	12
E 6007	31	25,5	16
F 6008	39,5	29,5	27

ES | Papeleras basic perforadas

Gama de papeleras metálicas perforadas pintadas epoxi, provistas de aro inferior de PVC. Disponibles en 12, 16 y 27 litros. Color standard gris RAL 7035. Bajo pedido ver gama de colores.

FR | Corbeilles Basic perforée

Gamme de corbeille à papier en métal époxy peint, équipé d'un anneau inférieure en PVC. Disponible en 12, 16 et 27 litres. Couleur standard gris RAL 7035. Consultez nous pour un coloris spécial.

IT | Gettacarte Basic perforato

Gamma di gettacarte metallici perforati verniciati epossidici, basi in PVC. Disponibile in 12, 16, 27 litri. Colore standard RAL 7035. Su richiesta vedere gamma di colori.

GB | Papelera basic punched

Smooth metal wastebaskets Range epoxy painted, fitted with PVC bottom ring. Available in 12, 16 and 27 liters. Standard colour gray RAL 7035. Ask us for a special colour.

DE | Sortiment von Metallpapierkörben

Sortiment von Metallpapierkörben, gelocht, epoxidlackiert, innerer Ring aus PVC. Erhältlich in 12, 16 und 27 Ltr. Standardfarbe grau RAL 7035. Auf Bestellung sind andere Farben möglich.

PO | Papeleiras Basic 6000 perfurado

Gama de papeleiras metálicas perfurado pintadas epoxi, com aro inferior em PVC. Disponíveis em 12, 16 e 27 litros. Cor standard cinzento RAL 7035. Por pedido podem ser pintadas de acordo com uma gama de cores.



*



E



A - D



* Ref. Standard
RAL: 7035

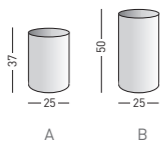

	↑	↔	L
A 02/P	37	25	18
B 03/P	50	25	25

	↑	↔	L
1 C546/YE	21	20 x 14	
2 C546/RO	21	20 x 14	
3 C546/GI	21	20 x 14	
4 C546/GR	21	20 x 14	



ES | Papeleras "Pieno"

Gama de papeleras de chapa pintada epoxy color gris. Disponibles en 37 y 50 cm. de altura y 25 cm., de diámetro. Ideales para la oficina y el hogar. Bajo pedido pueden solicitarse en colores burdeos, azul y negro. Opcional cubetas de colores.

FR | Corbeille à papier "Pieno"

Gamme de corbeilles en métal couleur gris époxy. Disponible en 37 et 50 cm de hauteur et en 25 et 50 cm de diamètre. Idéal pour les bureaux, etc... Sur commande, les corbeilles sont disponibles en couleur bordeaux, bleu et noir.

IT | Cestini "Pieno"

Gamma di cestini in acciaio verniciato grigio alluminio. Disponibile nelle altezze 37 cm, 50 cm e diametro 25 cm. Ideale per ufficio e casa. Finiture disponibili: bordeaux, blu e nero. Questa gamma ha come articolo opzionale il cestino per la raccolta differenziata.

GB | Wastepaper "Pieno"

Range of wastepaper bins painted with grey epoxy, they are curved and fixed with chrome head screws. Available in 37 and 50 cm high and 25 cm diameter. Ideal for the office and home. Bordeaux, blue and black colours can be ordered on request.

DE | Mülleimer "Pieno"

Mülleimer Papierkorb aus Blech, grau epoxy. 37 und 50 cm Höhe und 25 cm Ø Durchmesser verfügbar. Ideal für den privaten und gewerblichen Bereich. Auf Anfrage sind die Farben: bordeaux, blau und schwarz zu liefern.

PO | Papeleira "Pieno"

Gama de papeleiras em chapa pintada em epoxy na cor cinzenta. Disponíveis em 37 e 50 cm. de altura e 25 de diâmetro. Ideais para o escritório e casa. Com pedido podem solicitar-se na cor bordeaux, azul e preto. Opcional recipientes nas cores.



NEW

	↑	↔	L
A 6050	32	21	5
B 6051	39	25	12
C 6052	60	25	20
D 6053	61	30	30

	↑	↔	L
A 6050/I	32	21	5
B 6051/I	39	25	12
C 6052/I	60	25	20
D 6053/I	61	30	30

	↑	↔	L
E 6054	60	35	40

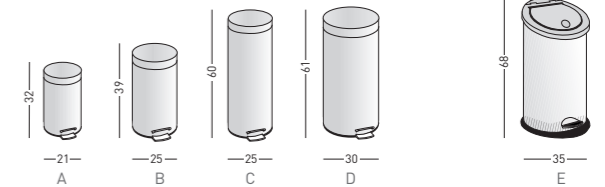

ES | Papeleras de pedal

Gama de papeleras metálicas con apertura de pedal. Incorporan cubeta de plástico con asa y están disponibles en 5, 12, 20, 30 y 40 litros. Colores blanco e inox.

FR | Corbeilles à pédale

Gamme de corbeilles métalliques avec ouverture par pédale. Avec un seau en plastique intérieur avec poignée sont disponibles en 5, 12, 20, 30 et 40 litres. Coloris blanc et acier inoxydable.

IT | Gettacarte a pedale

Gamma di gettacarte metallici con apertura a pedale. Incorporano un contenitore in plastica con asola e sono disponibili in 5, 10, 20, 30 e 40 litri. Colori bianco e inox.

GB | Pedal bins

Range of metal bins with pedal opening. Incorporating plastic bucket and handle are available in 5, 12, 20, 30 and 40 liters. Colours white and stainless steel.

DE | Sortiment von Metallpapierkörben

Sortiment von Metallpapierkörben mit Fussbedinung, beinhaltet einen Plastikeimer mit Griff, in den Größen 5, 12, 20, 30 und 40 Ltr. Erhältlich. Farben weiss und inox.

PO | Papeleiras de pedal

Gama de papeleiras metálicas de pedal. Dentro têm um balde de plástico com asa e estão disponíveis com 5, 12, 20, 30 e 40 litros. Cores: branco e inox.



212



213



* Ref. Standard
RAL: 7035

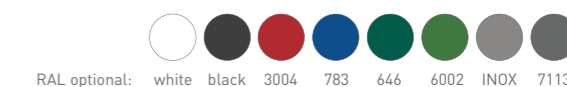

	↑↓	↔	L
A 6070	65,5	25,5	33
B 6071	65,5	25,5	33

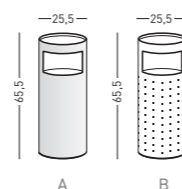

	↑↓	↔	↔	L
A 6030	65	31,5	26	41
B 6031	83	31,5	26	56

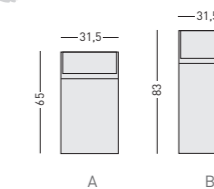

ES | Papelera metálica "Cestini"

Papelera metálica pintada en color gris ideal para centros comerciales y zonas de exterior. Apertura lateral por los dos lados y cinerero superior.

FR | Corbeille "Cestini" en métal

Corbeille en métal peint en gris. Idéal pour centres commerciaux et extérieur. Ouverture bilatérale et cendrier en partie supérieure.

IT | Cestino metallico "Cestini"

Cestino in metallo verniciato in grigio, ideale per i centri commerciali e aree esterne. Apertura laterale da entrambi i lati e posacenere superiore.

ES | Papelera metálica "Swing"

Papelera con apertura batiente de mediana capacidad ideal para centros comerciales y zonas de exterior. Disponible 2 tamaños. Cabezal basculante.

FR | Corbeille "Swing" en métal

Corbeille avec ouverture battante de capacité moyenne. Idéal centres commerciaux et extérieur. Disponible en 2 dimensions.

IT | Cestino "Swing" metallico

Cestino con apertura a porta battente di media capacità ideale per centri commerciali e spazi esterni. Disponibile in 2 formati.

GB | Metallic wastepaper bin "Cestini"

Wastepaper bin painted in grey. Ideal for shopping centers and outside. Bilateral opening and upper ashtray.

DE | Papiermülleimer "Cestini" aus Metall

Papiermülleimer aus Metall in den Farben grau. Ideal für Einkaufszentren und Außenbereiche. Beidseitige Öffnung, obenauf der Aschenbecher.

PO | Papeleira metálica "Cestini"

Papeleira metálica pintada em cinzento. Ideal para centros comerciais e zonas de exterior. Abertura lateral para ambos os lados e cinzeiro na parte superior.

GB | Metallic wastepaper bin "Swing"

Wastepaper bin with swing-open door of medium capacity. Ideal for shopping centers and outside. 2 sizes available.

DE | Papelera "Swing"

Papiermülleimer mit Klappöffnung. Ideal für Einkaufszentren und Außenbereiche. In vier verschiedenen Größen erhältlich.

PO | Papeleira metálica "Swing"

Papeleira com abertura de vaivem de média capacidade, ideal para centros comerciais e zonas de exterior. Disponível em 2 tamanhos.

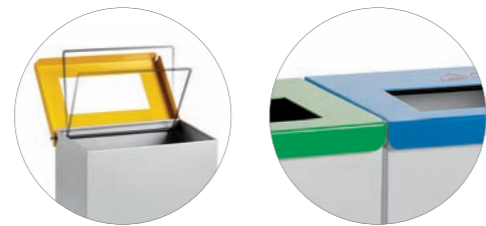

214



NEW

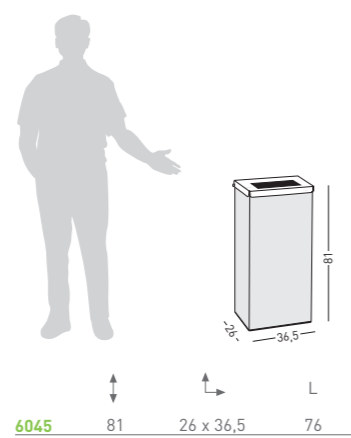

ES | Papelera de reciclaje

Papelera de reciclaje gris de 76 litros, con tapa abatible y aro interior para bolsa. Tapa superior disponible en 3 colores de reciclaje básicos. Ideal para oficinas, centros comerciales, etc...

FR | Corbeille de recyclage

Corbeille de recyclage de 76 litres, avec couvercle à charnière et bague intérieure pour le sac. Le couvercle es disponible en 3 couleurs de base de recyclage. Idéal pour les bureaux, les centres commerciaux...

IT | Gettacarte per riciclo

Gettacarte da riciclo grigio da 76 litri, con coperchio asportabile e elemento interno per la borsa. Coperchio superiore disponibile nei 3 colori dei ricicli di base. Ideale per uffici, centri commerciali, etc.

GB | Recycle bins

Recycle Bin 76 liters grey colour, with hinged lid and inner ring for bag. Top cover available in 3 basic colours recycling. Ideal for offices, shopping malls, etc ...

DE | Recyclingpapierkorb

Recyclingpapierkorb von 76 Ltr., grau, mit einem Klappdeckel und einem innerem Ring für die Beutel. Der Deckel ist in den 3 Grundfarben des Recyclings erhältlich. Ideal für Büros, Kaufhäuser etc..

PO | Papeleira para reciclagem

Papeleira cinzenta para reciclagem com capacidade para 76 litros, com tampa e aro interior para saco. Tampa superior disponível em 3 cores de acordo com as cores básicas da reciclagem. Ideal para escritórios, centros comerciais, etc...

215



NEW

	↑	↔	L
A 6040	42	60	21
B 6041	72	60	39

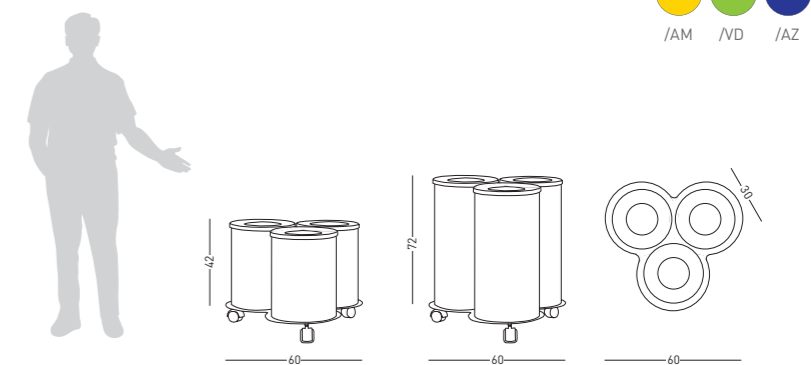

ES | Papelera de reciclaje

Papelera de reciclaje ignífuga de 42 y 72 cm de altura con base rodante y 3 contenedores de reciclaje colores standart para separación de residuos. Base con ruedas color negro.

FR | Corbeille de recyclage

Corbeille de recyclage ignifugée de 42 et 72 cm de haut avec socle roulant et 3 bacs de recyclage de couleurs pour le tri des déchets standard. Base avec roulettes noires.

IT | Gettacarte per riciclo

Gettacarte da riciclo ignifuga da 42 e 72 cm. di altezza con base ruotante e 3 contenitori con i colori del riciclo standard per la separazione dei rifiuti. Base con ruote colore nero.

GB | Recycle bins

Recycle Bin fireproof of 42 and 72 cm with rolling base and 3 colour recycling bins for waste separation standard. Base with wheels black.

DE | Feuerfester Recyclingpapierkorb

Feuerfeste Recyclingpapierkorb, 42 und 72cm hoch, rollbar, 3 Container standrt in den Grundfarben des Recyclings erhältlich, schwarze rollen.

PO | Papeleira para reciclagem

Papeleira para reciclagem com propriedades ignífugas com 42 e 72 cm de altura, base com rodas e 3 compartimentos de reciclagem para separação de resíduos. Base com rodas na cor preta.



216



NEW



	↑	↔	L	⊙
TRI/01/GR	80	49	150	49
TRI/01/NG	80	49	150	49

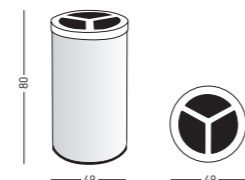

ES | Papelera de reciclaje TRI

Gama de papeleras TRI. Papelera metálica pintada gris o negro con tapa en acero inoxidable con vinilo según residuo. Dispone de 3 aros portabolsas en su interior. Ideal para oficinas, zonas comunes, office, etc... Disponible en color gris y negro.

FR | Corbeille de recyclage TRI

Gamme de corbeille TRI en métal peint en gris ou noir avec couvercle en acier inoxydable avec du vinyle selon le résidu. Avec un anneau porte-sac à l'intérieur. Idéal pour les bureaux, les espaces publics, bureaux... Disponible en gris et noir.

IT | Gettacarte da riciclo TRI

Gamma di gettacarte TRI. Gettacarte metallico verniciato nero o grigio con coperchio in acciaio inossidabile con vinile secondo rifiuti. Dispone di tre anelli portaborse al suo interno. Ideale per uffici, zone comuni, etc. Disponibile in colori grigio e nero.

GB | TRI recycle bins

TRI range bins. Trash metal painted gray or black with stainless steel cover with vinyl for each residue. Bag holder has 3 rings inside. Ideal for offices, public areas, office, etc ... Available in gray and black.

DE | Sortiment von Papierkörben TRI

Sortiment von Papierkörben TRI. Papierkorb aus Metall, grau lackiert, Deckel aus Edelstahl. Beinhaltet einen Ring für den Beutel. Ideal für Büros, öffentliche Räume etc... Erhältlich in Grau und Schwarz.

PO | Papeleira reciclagem TRI

Gama de papeleiras TRI. Papeleira metálica pintada em cinzento ou preto com tampa em aço inoxidável com vinil de cor consoante a cor básica de reciclagem. Dispõe de 3 aros no seu interior para colocar os sacos. Ideal para escritórios, zonas comuns, etc... Disponível em cinzento e preto.

217



	↑	↔	L
A PUSH/GA	88	33	50
B BIG/PUSH/GA	94	40	88

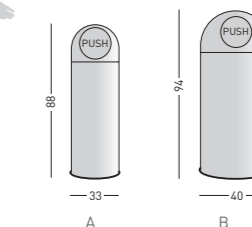

ES | Papeleras container "Push"

Papelera container con apertura redonda tipo "Push" con cierre retráctil, fabricadas en chapa pintada epoxy gris. Incorpora en su interior estructura de varilla para sujeción de bolsa de plástico.

FR | Corbeille à papier "Push"

Corbeille à ouverture ronde de type "Push". L'ouverture s'effectue par un mouvement de bascule. Fabriquée en tôle métallique laquée époxy couleur gris. Incluant à l'intérieur un support en métal pour mettre un sac en plastique.

IT | Cestini "Push"

Cestino con apertura tonda tipo "Push" con movimento rientrante, realizzati in acciaio verniciato grigio alluminio. Dotato di cestello interno "reggisacchetto" in tondino di acciaio zincato.

GB | "Push" Wastepaper

Push waste collectors with round self-closing access flap. They are painted with grey epoxy. An inner bar structure for fastening a plastic bag is included.

DE | "Push" Mülleimer

Push-Mülleimer, durch seine sehr praktische Push-Klappe können sie den Abfall sehr schnell verschwinden lassen. Ein sehr edles Design, aus Blech, grau epoxy. Inneres Gestänge für die Kunststoffüte.

PO | Papeleira "Push"

Papeleira com abertura redonda tipo "Push" com fecho retráctil, fabricada em chapa pintada em epoxy cinzento. Incorpora no seu interior uma estrutura de vareta para fixação do saco de plástico.



A



B



C



A

B

C



D



	L	H	W	D
A	BL/MO/0050	25 x 19	21	1,48
B	BL/MO/0051	35 x 9	25	0,68
C	BL/MO/0052	100 x 45	25	4,43

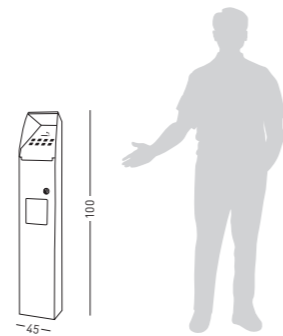
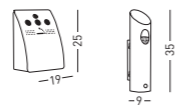

ES | Ceniceros para exterior

Gama de ceniceros de exterior. 2 modalidades a suelo o a pared todos ellos provistos con cerradura de seguridad. Ideal para situar en las entradas de espacios públicos y privados donde no está permitido fumar.

FR | Cendriers d'extérieur

Gamme de cendriers d'extérieurs. 2 modèles de sol ou mural tous fournis avec serrure de sécurité. Idéal pour les entrées dans les espaces publics et privés où fumer est interdit.

IT | Posacenere per esterno

Gamma di posacenere per esterno. 2 tipologie, da terra e a parete, tutti dotati di serratura di sicurezza. Ideale da posizionare all'ingresso degli spazi pubblici e privati dove è vietato fumare.

GB | Outdoor ashtrays

Range of outdoor ashtrays. 2 models, for floor or wall all provided with security lock. Ideal for entries and in public or private spaces where smoking is not permitted

DE | Sortiment von Aussenaschenbechern

Sortiment von Aschenbechern für den Aussenbereich. Als Ständer oder zum Anbringen an der Wand, beide mit Sicherheitsschloss. Ideal an Eingängen von Räumen in denen Rauchen untersagt ist.

PO | Cinzeiros para exterior

Gama de cinzeiros para exterior. Para aplicar na parede ou no chão, sendo que todos eles estão equipados com fechadura. Ideal para as entradas dos edifícios públicos ou privados onde não está permitido fumar.

ES | Perchero

Colección de percheros disponibles en versión mural de pie y con ruedas. Fabricados con tubo de acero pintado epoxi negro, gris o blanco y disponible con varios colgadores según modelo. Ideal para tanto para la oficina como el hogar.

GB | Coat rack

Collection of wall mounted coat racks or standing with wheels. Made of steel tube painted in gray, black or white. And with several hangers available depending on model. Ideal for both office and home.

FR | Porte-manteau

Collection de porte-manteaux disponible en version murale, sur piétement et avec roulettes. Fabriqué en tube en acier peint en gris, noir ou blanc. Plusieurs boules disponibles selon le modèle. Idéal pour les bureaux et la maison.

DE | Sortiment von Kleiderständern

Sortiment von Kleiderständern, erhältlich zur Wandmontage, als Ständer oder rollbar. Hergestellt aus epoxilackiertem Stahlrohr in den Farben Grau, Schwarz oder Weiss. Je nach model sind verschiedene Haken möglich. Ideal fürs Büro und Zuhause.

IT | Appendiabiti

Collezione di appendiabiti disponibili in versioni da parete, da terra e con ruote. Realizzati con tubolare di acciaio verniciato epossidico nero, grigio o bianco e disponibile con vari appendini a secondo del modello. Ideale sia per l'ufficio che per casa.

PO | Cabide

Coleção de cabides disponíveis em versão de pé, de parede ou com rodas. Fabricados com tubo em aço pintado na cor cinzenta, preta ou branca. Disponíveis com vários cabides consoante o modelo. Ideal tanto para o escritório como para casa.

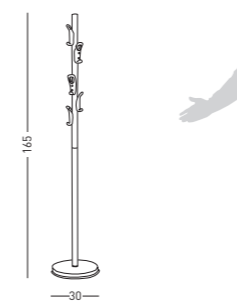

A	6110/GR	165	30	6
B	6110/NG	165	30	6
	6110/BL	165	30	6

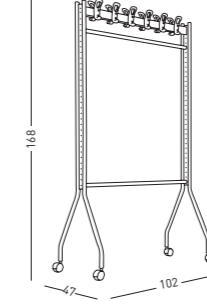

C	6115/GR	168	102	47	12
	6115/NG	168	102	47	12
	6115/BL	168	102	47	12

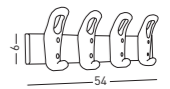

D	6113/GR	6	54	4
	6113/NG	6	54	4
	6113/BL	6	54	4

6100



A

B

C

NEW

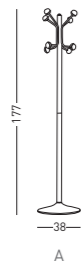

A

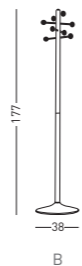

B

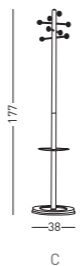

C



RAL 7035

A	6100	177	38	8	-
---	------	-----	----	---	---

B	6101	177	38	8	-
C	6102	177	38	8	Si/Yes

ES | Percheros

Colección de percheros de pié metálicos pintados epoxi gris. Provistos de 8 colgadores de bola. La ref. 6102 incorpora aro paraguero. Ideales tanto como para el mundo de la oficina como el habitat.

FR | Porte-manteau

Collection de porte-manteaux en époxy peint en gris et pied en métal. Armé de huit boules. Le réf. 6102 intègre un anneau porte parapluie. Idéal pour les bureaux et l'habitat.

IT | Appendiabiti

Collezione di appendiabiti da terra metallici e verniciati epossidici grigio. Dotati di 8 appendini a forma di palla. Ref. 6102 comprende un portaobrelli. Ideale sia per l'ufficio che per la casa.

GB | Coat rack

Collection of racks of gray epoxy painted metal foot. Armed with eight ball hangers. The ref. 6102 incorporates umbrella ring. Ideal as to the world of office as the habitat...

DE | Sortiment von Kleiderständern

Sortiment von Kleiderständern mit grau epoxilackiertem Stahlfuß. Mit 8 Aufhängekugeln. Das Model 6102 beinhaltet einen Ring für Regenschirme. Ideal fürs Büro und Zuhause.

PO | Cabides

Coleção de cabides de pé metálicos e pintados em epoxi cinzento. Com capacidade para 8 cabides. A Ref. 6102 tem um aro para guarda-chuvas. Ideais para todo o tipo de ambientes...

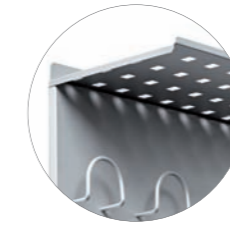

6120



A



D



C



B

NEW

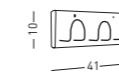

A

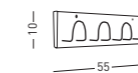

B

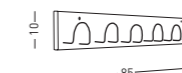

C

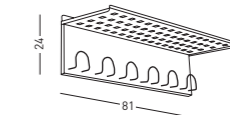

D

		↑	↔	●
A	6120/3	10	41	3
B	6120/4	10	55	4
C	6120/6	10	85	6
D	6120/4R	24	81	6



RAL 7035

ES | Percheros

Colección de percheros de pié metálicos pintados epoxi gris. Provistos de 8 colgadores de bola. La ref. 6102 incorpora aro paraguero. Ideales tanto como para el mundo de la oficina como el habitat.

FR | Porte-manteau

Collection de porte-manteaux en époxy peint en gris et pied en métal. Armé de huit boules. Le réf. 6102 intègre un anneau porte parapluie. Idéal pour les bureaux et l'habitat.

IT | Appendiabiti

Collezione di appendiabiti da terra metallici e verniciati epossidici grigio. Dotati di 8 appendini a forma di palla. Ref. 6102 comprende un portaobrelli. Ideale sia per l'ufficio che per la casa.

GB | Coat rack

Collection of racks of gray epoxy painted metal foot. Armed with eight ball hangers. The ref. 6102 incorporates umbrella ring. Ideal as to the world of office as the habitat...

DE | Sortiment von Kleiderständern

Sortiment von Kleiderständern mit grau epoxilackiertem Stahlfuß. Mit 8 Aufhängekugeln. Das Model 6102 beinhaltet einen Ring für Regenschirme. Ideal fürs Büro und Zuhause.

PO | Cabides

Coleção de cabides de pé metálicos e pintados em epoxi cinzento. Com capacidade para 8 cabides. A Ref. 6102 tem um aro para guarda-chuvas. Ideais para todo o tipo de ambientes...

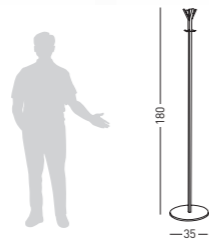
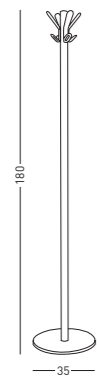

EC/01/BL	180	35	4 + 4
EC/01/NG	180	35	4 + 4

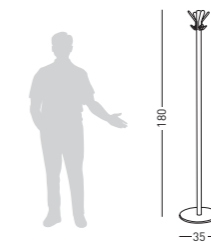
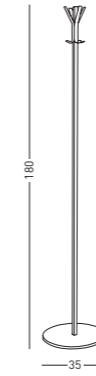

EC/02/BL	180	35	4 + 4
EC/02/NG	180	35	4 + 4

ES | Perchero ECOT

Perchero metálico de tubo cuadrado de 2x2 gran ligereza y estabilidad gracias a su base. Disponible con 4 ganchos dobles en su parte superior y pintados en colores negro y blanco. Ideal para la oficina, y el habitat. Bajo demanda y según cantidad pueden solicitarse colores especiales.

GB | ECOT coat hanger

Coat hanger made of light metal square tube 2x2 and with a good stability thanks to its base. Available with 4 double hooks at the top and painted in black and white colours. Ideal for office, and habitat. In function of quantity you can ask for special colours.

FR | Porte-manteau ECOT

Porte-manteau en tube métal tube carré 2x2, léger et stable grâce à sa base. Disponible avec 4 crochets doubles en partie supérieures et peint en noir et blanc. Idéal pour le bureau et l'habitat. Sur demande et en fonction des quantités option de couleurs spéciales.

DE | Kleiderständer aus Metall

Kleiderständer aus Metall, quadratisches Rohr 2x2, sehr elegant, standfest dank seines Fusses. Erhältlich mit 4 Doppelhaken in den Farben schwarz und weiss für denoberen Bereich. Ideal fürs Büro und Zuhause. Auf Wunsch sind auch andere Farben möglich.

IT | Appendiabiti ECOT

Appendiabiti metallico con tubolare e sezione quadrata 2x2, leggero e stabile grazie al suo basamento. Disponibile con 4 ganci doppi nella sua parte superiore e verniciato nei colori nero e bianco. Ideale per l'ufficio e la residenza. Su richiesta e secondo la quantità è possibile con colori speciali.

PO | Cabide ECOT

Cabide metálico em tubo quadrado 2x2 muito ligeiro e estável devido à sua base. Disponível com 4 ganchos duplos em cima e pintados na cor preta ou branca. Ideal para o escritório. Por pedido e de acordo com algumas quantidades poderá ser fabricado em outras cores.

ES | Perchero ECOT/2

Perchero metálico de tubo redondo 5 cm. de gran ligereza y estabilidad gracias a su base. Disponible con 4 ganchos dobles en su parte superior y pintados en colores negro y blanco. Ideal para la oficina, y el habitat. Bajo demanda y según cantidad pueden solicitarse colores especiales.

GB | ECOT coat hanger

Coat hanger made of light metal round tube 5 cm. and with a good stability thanks to its base. Available with 4 double hooks at the top and painted in black and white colours. Ideal for office, and habitat. In function of quantity you can ask for special colours.

FR | Porte-manteau ECOT/2

Porte-manteau en tube métal rond 5 cm., léger et stable grâce à sa base. Disponible avec 4 crochets doubles en partie supérieures et peint en noir et blanc. Idéal pour le bureau et l'habitat. Sur demande et en fonction des quantités option de couleurs spéciales.

DE | Kleiderständer aus Metall

Kleiderständer aus Metall, rundes 5 cm., sehr elegant, standfest dank seines Fusses. Erhältlich mit 4 Doppelhaken in den Farben schwarz und weiss für denoberen Bereich. Ideal fürs Büro und Zuhause. Auf Wunsch sind auch andere Farben möglich.

IT | Appendiabiti ECOT/2

Appendiabiti metallico con tubolare e sezione rotonda 5 cm., leggero e stabile grazie al suo basamento. Disponibile con 4 ganci doppi nella sua parte superiore e verniciato nei colori nero e bianco. Ideale per l'ufficio e la residenza. Su richiesta e secondo la quantità è possibile con colori speciali.

PO | Cabide ECOT

Cabide metálico em tubo redondo 5 cm. muito ligeiro e estável devido à sua base. Disponível com 4 ganchos duplos em cima e pintados na cor preta ou branca. Ideal para o escritório. Por pedido e de acordo com algumas quantidades poderá ser fabricado em outras cores.

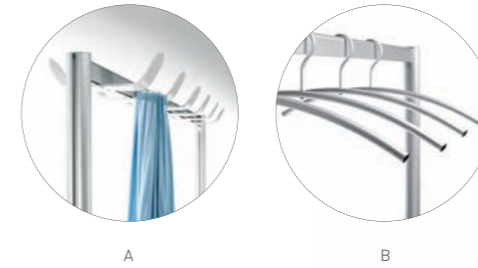

224



225

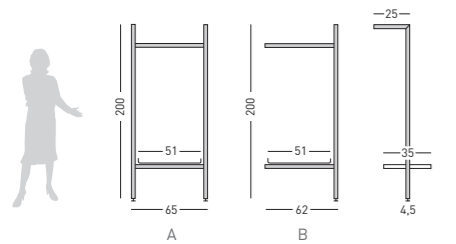

A	TS/PER/MT	200 x 65	25	4,5
B	TS/PER/MX	200 x 62	25	4,5

PER/1	19	40
-------	----	----

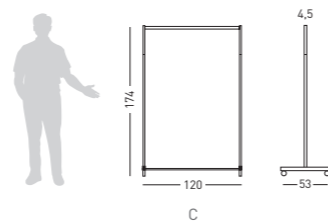

C	TS/BUR/R	174 x 120	53	4,5
---	----------	-----------	----	-----

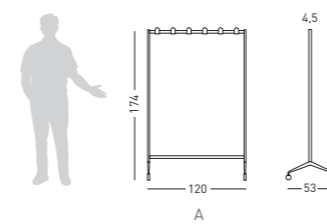

A	TS/PER/R	174 x 120	53	4,5
---	----------	-----------	----	-----

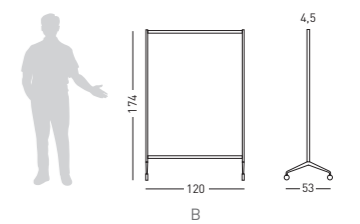

B	TS/PER/RB	174 x 120	53	4,5
---	-----------	-----------	----	-----

ES | Perchero mural de aluminio "TEN"
Perchero mural fabricado con perfil de aluminio plata mate "TEN". Se fija a la pared mediante los brazos separadores y se apoya al suelo. Disponible kit de ampliación ref. TS/PER/MX.

FR | Portemanteau mural en aluminium "TEN"
Portemanteau mural en aluminium "TEN". Un point de fixation mural et appui au sol sur piétement. Kit d'extension disponible. Barre de suspension pour cintres et tablette inférieure pour sacs et casques, incluses.

IT | Appendiabiti da parete in alluminio "TEN"
Appendiabiti da parete fabbricato con profilo in alluminio "TEN". Si fissa alla parete mediante i bracci separatori e si appoggia al suolo mediante una base. Disponibile il kit di ampliamento. Include una barra superiore e uno scaffale inferiore.

ES | Perchero "TEN" con ruedas
Perchero con ruedas (2 con freno) fabricados con perfil de aluminio anodizado plata mate "TEN". El perchero incluye 6 brazos dobles (12 perchas) y 2 bases de plexiglas blanco en la parte inferior.

FR | Portemanteau "TEN" avec roulettes
Portemanteau sur roulettes (dont 2 avec frein) en aluminium anodisé "TEN". 6 patères doubles et 2 tablettes inférieures pour sacs et casques en plexiglas.

IT | Appendiabiti "TEN" con ruote
Appendiabiti con ruote (2 con freno) fabbricato con profilo in alluminio anodizzato colore argento opaco "TEN". L'appendiabiti include 6 bracci doppi (12 grucce) e 2 basi in plexiglas situate nella parte inferiore.

GB | Aluminium wall coat-hanger "TEN"
Wall coat-hanger in aluminium. One wall fixation and one floor support. Extension set available. Hanging rod for hangers and lower tray for bags and helmets included.

DE | Wandgarderobenständer "TEN"
Wandgarderobenständer aus einem Aluminiumprofil "TEN". Durch Trennarne kann diese an die Wand befestigt werden, und durch den Standfuß stützt sich diese am Boden ab. Verlängerungsset verfügbar.

PO | Cabide de parede em alumínio "TEN"
Cabide de parede fabricado com perfil de alumínio "TEN". É fixado à parede através dos braços separadores e é apoiado no chão através da base. Disponível um kit de ampliação, para poder ser adequado ao espaço desejado.

GB | Metallic coat-hanger "TEN" with castors
Coat-hanger on castors (including 2 brakes) in anodized aluminium. 6 double pegs and 2 lower trays for bags and helmets in plexiglas.

DE | Garderobenständer "TEN" mit Rädern
Garderobenständer mit Rädern (2 Bremsen) aus einem Aluminiumprofil, matt-silber "TEN". Die Garderobe beinhaltet 6 Doppelarme (12 Kleiderhaken) im unterem Bereich befinden sich zwei Plexiglas-Elemente.

PO | Cabide em alumínio "TEN" com rodas
Cabide com rodas (2 com travão) fabricado com perfil de alumínio "TEN". O cabide inclui 6 cabides duplos (para 12 cabides) e 2 bases em plexiglas branco na parte inferior.



226

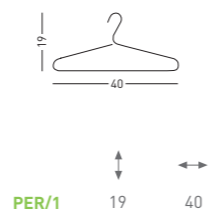
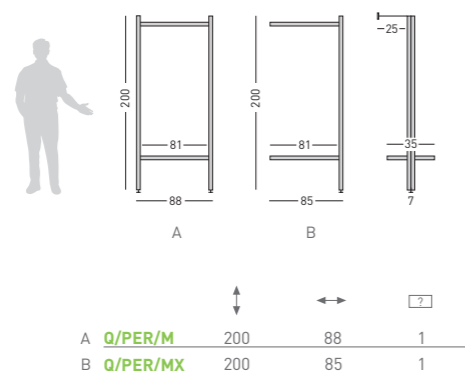
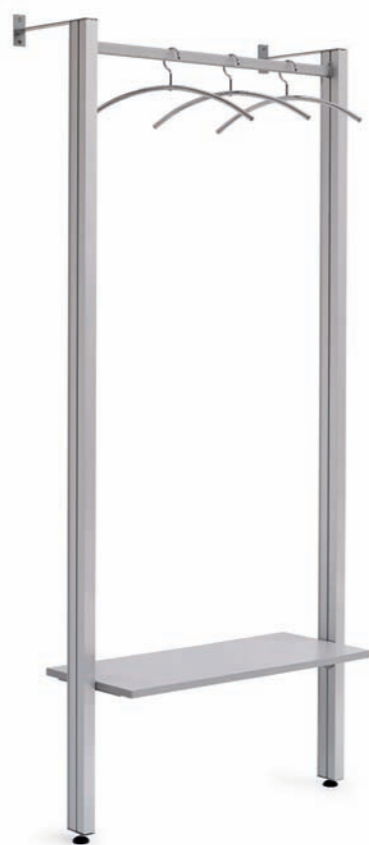

ES | Perchero mural de aluminio "Quadra"
Perchero mural fabricado con perfil de aluminio plata mate "Quadra". Se fija a la pared mediante los brazos separadores y se apoya al suelo mediante la base. Disponible kit de ampliación para poder continuar el perchero a la medida deseada.

FR | Porte-manteau en aluminium "Quadra"
Porte-manteau mural en aluminium couleur argent "Quadra" sur socle. Se fixe au mur à l'aide d'une patte de fixation. Un kit de crochets empilables est disponible pour continuer le porte manteau jusqu'à la hauteur souhaitée.

IT | Appendiabiti da parete "Quadra"
Appendiabiti a muro in resistente alluminio anodizzato profilo "Quadra". Consegnato con separatori da fissare al muro e base da pavimento. E' disponibile un kit per fare la misura desiderata. Una barra in alto ed una mensola laminata grigia in basso sono incluse.

GB | Wall rack "Quadra"
Wall rack manufactured with matt silver anodised aluminium profile "Quadra". Delivered with separator brackets to fix it to the wall and a base to put it in the floor. An extension kit is available to fit it with the desired size.

DE | Alu-Wandgarderobenständer "Quadra"
Wandgarderobenständer "Quadra" aus mattsilber Alu-Profil hergestellt. An die Wand durch Trennarmer befestigt und mit einem Standfuß stützt sich er auf dem Boden. Vergrößerung-set verfügbar, um das Produkt auf Wunsch zu verlängern.

PO | Cabide de parede "Quadra"
Cabide de parede fabricado com perfil de alumínio na cor prata mate "Quadra". É fixado à parede mediante os braços separadores e apoia-se no chão. Disponível kit de ampliação para poder continuar o cabide até à medida desejada.

227

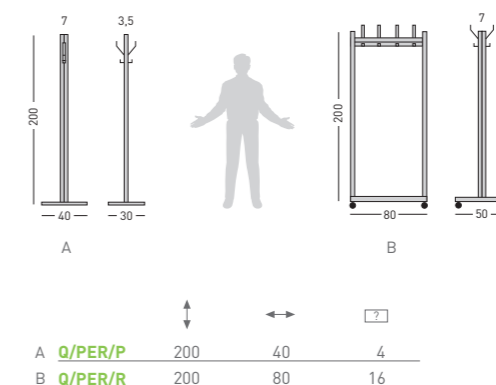

ES | Perchero de ruedas y pié "Quadra"
Perchero con ruedas (2 con freno) o de pié fabricados con perfil de aluminio anodizado plata mate "Quadra". El modelo de ruedas incluye 4 perchas dobles (doble cara) y el modelo de pié incorpora 2 ganchos dobles y una base metálica pintada gris.

FR | Porte-manteau en aluminium "Quadra"
Porte-manteau mural à roulettes ou sur pied en aluminium couleur argent "Quadra". Un kit de crochets empilables est disponible pour continuer le porte manteau jusqu'à la hauteur souhaitée.

IT | Appendiabiti a pavimento "Quadra"
Appendiabiti su ruote (2 con freno) o da pavimento in alluminio anodizzato naturale "Quadra". Il modello è provvisto con ruote ha 4 doppi appendiabiti (bifacciale) quello a pavimento ha 2 ganci ed una base metallica verniciata.

GB | Aluminium racks "Quadra"
Rack with castors (2 with brake) or floor-placed manufactured with matt silver anodised aluminium profile "Quadra". The model provided with castors has 4 double hangers (double-sided) and the floor one has 2 double hooks and a metallic base painted in grey.

DE | Alu-Garderobenständer "Quadra"
Garderobenständer "Quadra" mit Standfuß oder fahrbar (2 Rollen mit Bremsen) aus mattsilber Alu-Profil hergestellt. Der Garderobenständer mit Laufrollen ist mit 4 Kleiderbügel (zweiseitig) ausgestattet und der Standfuß-Garderobe mit 2 Haken und eine Metal-Fuß.

PO | Cabide com rodas e de pé "Quadra"
Cabide com rodas (2 com travão) ou de pé, fabricados com perfil de alumínio anodizado na cor prata mate "Quadra". O modelo de pé incorpora 2 ganchos duplos e uma base metálica pintada a cinzento.

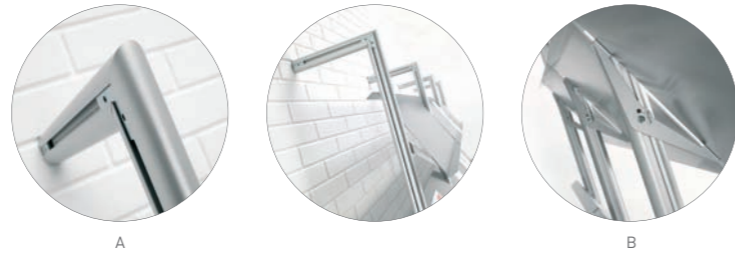

A
estante
plano

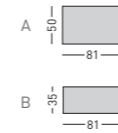

ES - Estante plano de madera
GB - Wood plane shelf
FR - Tablette plane bois
DE - Flache regalboden
IT - Mensola piana di legno
PO - Prateleira plana de madeira



	A	↑	→
1	214/EP/H	50 x 81	1,6
2	214/EP/W	50 x 81	1,6
3	214/EP/G	50 x 81	1,6
4	214/EP/C	50 x 81	0,5

	B	↑	→
1	214/EP/H1	35 x 81	1,6
2	214/EP/W1	35 x 81	1,6
3	214/EP/G1	35 x 81	1,6
4	214/EP/C1	35 x 81	0,5



B
estante
inclinado

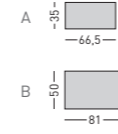

ES - Estante inclinado metálico
GB - Metal inclined shelf
FR - Tablette inclinée
DE - Schiefe regalboden
IT - Mensola inclinata
PO - Prateleira inclinada

ES - Estante inclinado de madeira
GB - Wood inclined shelf
FR - Tablette inclinée bois
DE - Schiefe regalboden
IT - Mensola inclinata di legno
PO - Prateleira inclinada de madeira



	A	↑	→
	TS/242/EI	35 x 66,5	0,2

	B	↑	→
1	214/EI/H	50 x 81	1,6
2	214/EI/W	50 x 81	1,6
3	214/EI/G	50 x 81	1,6



C
bucks

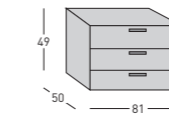

	A	↑	→
1	216/BKR/H	49 x 81 x 50	3
2	216/BKR/W	49 x 81 x 50	3
3	216/BKR/G	49 x 81 x 50	3

	B	↑	→
1	216/BKN/H	49 x 81 x 50	3
2	216/BKN/W	49 x 81 x 50	3
3	216/BKN/G	49 x 81 x 50	3

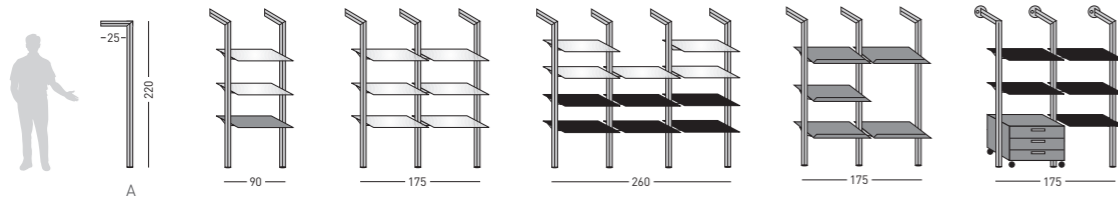

	A	↑	→
	TS/242/P	220	25

	B	↑	→
	TS/242/SE	3 x 25	

ES | Sistema de estantería "TEN"

Perfilería de aluminio anodizada plata mate para equipar comercios, vestidores, oficinas, etc... Gracias a su modularidad permite confeccionar estantería de la medida deseada. Se compone de perfil vertical, juego de soportes graduable y estantes.

FR | Etagère modulaire system "TEN"

Etagère modulaire en aluminium anodisé "Ten", idéal pour les bureaux, commerces, vestiaires... (nombreuses configurations possibles). Composé d'un profil vertical avec fixation murale, d'un jeu de pattes de fixation réglables, diverses finitions/couleurs.

IT | Sistema di profilati "TEN"

Sistema di profilati in alluminio anodizzato color argento opaco per fornire negozi, uffici, ecc. Il sistema è composto da un profilo verticale con separatore a parete, una serie di supporti regolabili e scaffali con rifiniture e colori diversi.

GB | Modular system "TEN"

Modular shelf in anodized aluminium. Ideal for offices, shops, cloakrooms... (various layouts possible). Composed of a vertical profile with wall fixation and a set of brackets. Various colors/finishings.

DE | Profil-System "TEN"

Profil-System aus anodisiertem Aluminium eloxiert, das dafür geeignet ist, um Läden, Büros, Ankleideräume, auszustatten. Dieses modulare System sorgt für das Zusammensetzen der Regale je nach gewünschter Maß. Das System besteht aus Eisenbeschläge.

PO | Sistema de perfis "TEN"

Sistema de perfis em alumínio anodizado na cor prata mate, para equipar lojas, escritórios, vestiários, etc. O sistema é composto por um perfil vertical com um separador para a parede, conjunto de suportes ajustáveis e diversos acabamentos e cores de prateleiras.



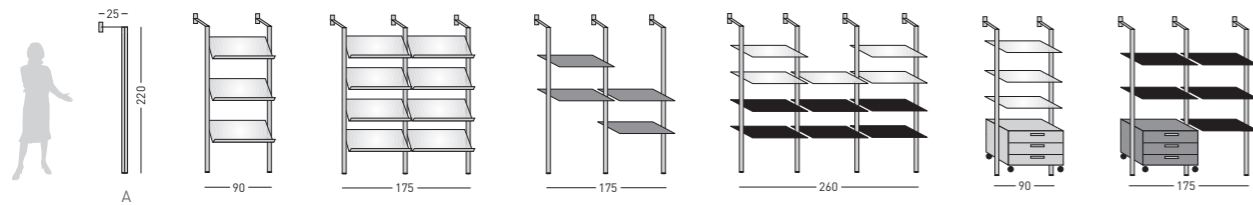

A 232/P 220 25

B 232/SE 3 x 25

ES | Sistema de estantería "Quadra"
Sistema de estantería formado por el perfil de aluminio serie "Quadra" ideal para equipar comercios, oficinas, vestidores, etc... Su práctico sistema de montaje permite acoplar perfiles hasta configurar una estantería según el espacio deseado.

GB | Shelving system "Quadra"
Shelving system composed of the aluminium profile "Quadra" ideal for shops, offices, dressing rooms, etc... A practical mounting system to connect profiles in order to create a shelf according to the desirable space.

FR | Système d'étagères "Quadra"
Système d'étagère formé de profilés aluminium série "Quadra", idéal pour équiper les commerces, bureaux, vestiaires, etc... Son système de montage pratique permet d'assembler les profilés afin de composer une grande variété d'étagères fonctionnelles.

DE | Alu-Profil "Quadra"
Alu-Profil System, Model "Quadra", ideal für die Einrichtung von Geschäften, Büros, Ankleidebereiche, etc. Einfache Montage von einer vielfältigen Grundregalelemente, die Sie in beliebiger Anzahl kombinieren können.

IT | Profilo verticale "Quadra"
Sistema di scaffali composto da profilo Quadra ideale per negozi, uffici, spogliatoi, ecc... Un pratico sistema di montaggio per connettere i profili per creare scaffalature a seconda dei moduli desiderati.

PO | Sistema de prateleiras "Quadra"
Sistema para prateleiras formado por um perfil em alumínio série "Quadra" Ideal para equipar lojas, escritórios, vestiários, etc... O seu práctico sistema de montagem permite juntar perfis até configurar uma estante segundo a dimensão desejada.

A
estante plano

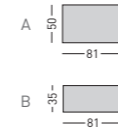

	A	↑	→
1	214/EP/H	50 x 81	1,6
2	214/EP/W	50 x 81	1,6
3	214/EP/G	50 x 81	1,6
4	214/EP/C	50 x 81	0,5

- ES - Estante plano de madera
- GB - Wood plane shelf
- FR - Tablette plane bois
- DE - Flache regalboden
- IT - Mensola piana di legno
- PO - Prateleira plana de madeira



B
estante inclinado

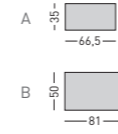

	A	↑	→
	232/EI	35 x 66,5	0,2

- | | |
|--|---|
| <p>A</p> <ul style="list-style-type: none"> ES - Estante inclinado metálico GB - Metal inclined shelf FR - Tablette inclinée DE - Schiefe regalboden IT - Mensola inclinato PO - Prateleira inclinada | <p>B</p> <ul style="list-style-type: none"> ES - Estante inclinado de madera GB - Wood inclined shelf FR - Tablette inclinée bois DE - Schiefe regalboden IT - Mensola inclinato di legno PO - Prateleira inclinada de madeira |
|--|---|

	B	↑	→
1	214/EI/H	50 x 81	1,6
2	214/EI/W	50 x 81	1,6
3	214/EI/G	50 x 81	1,6

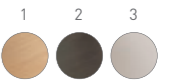

C
bucks

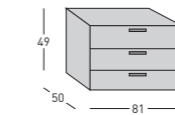

	A	↑	→
1	216/BKR/H	49 x 81 x 50	3
2	216/BKR/W	49 x 81 x 50	3
3	216/BKR/G	49 x 81 x 50	3

	B	↑	→
1	216/BKN/H	49 x 81 x 50	3
2	216/BKN/W	49 x 81 x 50	3
3	216/BKN/G	49 x 81 x 50	3

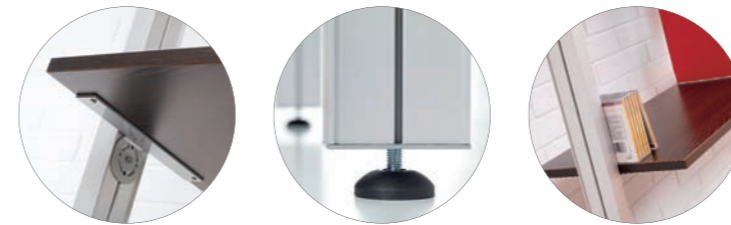

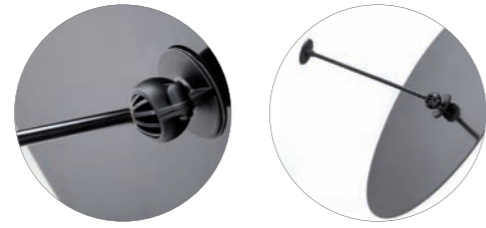

NEW

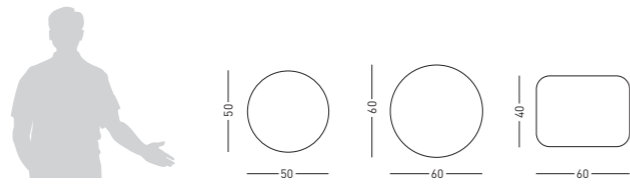

	↑	∅	Dist. (m.)	
A	EV/500	50 x 50	50	6
B	EV/600	60 x 60	60	8
C	EV/6040	40 x 60	40 x 60	12

ES | Espejos de vigilancia

Gama de espejos de vigilancia de alta calidad. Muy sencillos de instalar están dotados de una rótula orientable que permite un radio de giro de 105°. Recomendado para la vigilancia en tiendas, control de cajas, control de accesos en empresas, pasillos, etc...

FR | Miroir de surveillance

Gamme de miroir de surveillance avec reflet de haute qualité. Très simple à installer, munies d'un joint à rotule qui permet un rayon de braquage de 105°. Recommandé pour la surveillance en magasin, contrôle de caisses, les d'accès, couloirs, vols...

IT | Specchio per la vigilanza

Molto facile da installare, sono dotati di un elemento rotante orientabile che permette un raggio di 105°. Raccomandato per la vigilanza dei negozi, controllo delle casse, controllo degli accessi (entrare delle aziende, passaggi degli ospedali, etc.)

GB | Surveillance mirrors

Range surveillance mirrors of high quality. Very simple to install are provided with a swivel joint which enables a turning radius of 105°. Recommended for in-store surveillance, control boxes, access control companies, corridors, etc ...]

DE | Sortiment von Überwachungsspiegeln

Sortiment von hochwertigen Überwachungsspiegeln. Einfach anzubringen, lässt sich um 105-Grad drehen, empfehlenswert für Geschäfte, Kassenkontrollen, Eingänge, Flure etc...

PO | Espelho de vigilância

Gama de espelhos de vigilância de alta qualidade. Muito simples de instalar, estão capacitados de uma rótula orientável para permitir a visualização a 105°. Recomendado para a vigilância em lojas, controle de caixas registradoras, controle de acessos em empresas, passeios, etc...



A

B - C



NEW

* Suplemento 2 bicicletas
* Suplement 2 bicycles

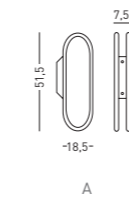

A

	↑	←→	places	
A	AB/01	51,5 x 18,5	7,5	1

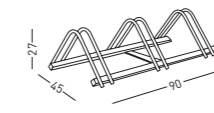

B

	↑	←→	places	
B	AB/03	27 x 45	90	3
* C	AB/02	27 x 45	84	2

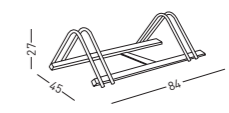

C

ES | Aparcabicicletas modular

Aparcabicicletas de hierro galvanizado modular que le permite añadir tantas extensiones como precise. Tubos de acero de 30x30 mm. Y varilla de diámetro 16 mm. Válido para todo tipo de bicicletas. Separación entre arcos de 5 cm. Disponible en 1, 2 ó 3 plazas.

FR | Gare vélos

Râteliers pour vélo en fer galvanisé, modulaire il permet d'ajouter autant d'extensions selon vos besoins. Les tubes en acier 30x30 mm et tige 16 mm de diamètre. Convient à tous les types de vélos. La séparation entre les arcs est de 5 cm. Disponible en modules de 1 ou 2.

IT | Rastrelliera modulare

Rastrelliera di ferro galvanizzato modulare che permette di estenderla quanto necessario. Tubolare di acciaio di 30x30 mm. e ruota di diam. 16 mm. Valida per qualsiasi tipo di bicicletta. Distanziare ogni 5 cm. Disponibile in 1, 2, 3 pezzi.

GB | Bicycle stands

Bicycle stands made of galvanized iron and modular allowing you to add as many extensions as needed. Steel pipes 30x30 mm. Y 16 mm diameter rod. Suitable for all types of bikes. Separation between arches of 5 cm. Available as model 1, 2 or squares.

DE | Verzinkter Fahrradständer

Fahrradständer aus verzinktem Stahl hergestellt, es lassen sich beliebig viele Module zusammenstellen. Stahlrohr von 30 x 30mm und Stangen von 16mm Durchmesser, für alle Arten von Fahrrädern geeignet. Abstand zwischen den Bögen beträgt 5cm., je nach Modell erhältlich für 1, 2, Plätze.

PO | Aros para estacionar bicicletas

Aros para estacionar bicicletas em ferro galvanizado modular que permite colocar extensões de acordo com as necessidades. Tubos em aço com 30x30 mm. Vareta metálica com 16mm de diâmetro. Adaptável a qualquer tipo de bicicleta. Separação entre arcos de 5 cm. disponível para 1, 2 ou 3 bicicletas.

STANDY

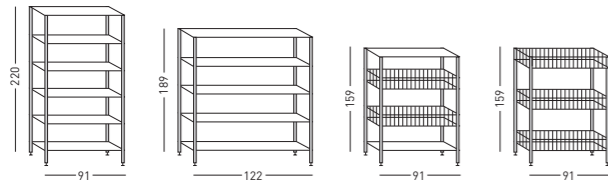
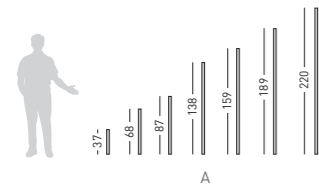
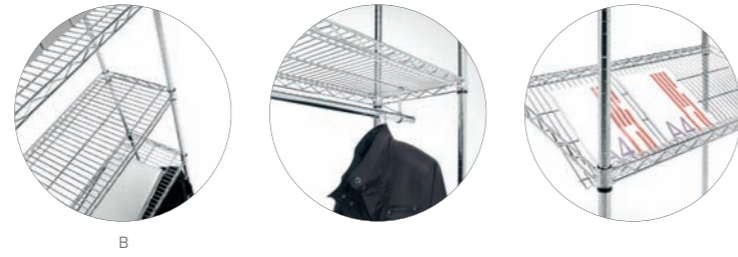

A	↑	↔
ST/90037	37	3
ST/90068	68	3
ST/90087	87	3
ST/90138	138	3
ST/90159	159	3
ST/90189	189	3
ST/90220	220	3

B	↑	↔
ST/93061	35 x 61	3,5
ST/93076	35 x 76	3,5
ST/93091	35 x 91	3,5
ST/93122	35 x 122	3,5
ST/93152	35 x 152	3,5
ST/94061	45 x 61	3,5
ST/94076	45 x 76	3,5
ST/94091	45 x 91	3,5
ST/94122	45 x 122	3,5
ST/94152	45 x 152	3,5

ES | Sistema "Standy"
Sistema "Standy" de estantería modular fabricado en acero inoxidable. Sistema componible con múltiples accesorios para realizar el sistema de almacenaje deseado. Estantes disponible en 35 y 45 cm.

FR | Système "Standy"
Système "Standy" Etagères modulaires en acier inoxydable. Imaginez et réalisez votre étagère sur mesure, de nombreux accessoires sont disponibles pour faire le rangement désiré. Etagère disponibles en 35 ou 45 cm.

IT | Sistema "Standy"
Sistema "Standy" per libreria modulare fabbricata in acciaio inossidabile. Sistema componibile con accessori multipli per ottenere l'immagazzinamento desiderato. Disponibile nelle misure di profondità di 35 e 45 cm. Con possibilità di applicare rotelle.

GB | "Standy" system
Modular shelf system "Standy" made of Stainless steel. Make and realize your own one with a lot of accessories for all kind of storage. Shelves available in 35 or 45 cm.

DE | "Standy" System
Modular Regal-System aus anodisiertem Aluminium eloxiert. Dieses System besteht aus verschiedenen Zubehörteile für die gewünschte Lagerung. Vergöbar in 35 cm und 45 cm Tiefe und die Option von Rollen.

PO | Sistema "Standy"
Sistema de prateleiras modulares "Standy", fabricado em aço inoxidável. O sistema é composto por múltiplos acessórios, para poder compor o sistema de armazenagem desejado. Disponível com profundidades de 35 e 45 cm.

A



ST/97500

ES - Kit de 4 ruedas
GB - Kit of 4 casters
FR - Jeux de 4 roulettes
DE - 4-Rad-Kit
IT - Kit 4 ruote
PO - Conjunto de 4 rodas



ST/97903

ES - Kit de 4 niveladores triangulares
GB - Leveling feet screw
FR - Verrins
DE - 4 dreieckige-Nivelierfüße Kit
IT - Base triangolare spianator
PO - Nivelador triangular

B



ST/97363 3,5 x 61 cm.
ST/97370 3,5 x 76 cm.
ST/97391 3,5 x 91 cm.
ST/97322 3,5 x 122 cm.
ST/97373 3,5 x 152 cm.

ES - Barra colgador
GB - Hanging bar
FR - Barre pour cintre
DE - Aufhängevorrichtung
IT - Barra appendiabiti
PO - Barra para pendurar cabides

C



ST/94290 45 x 90 x 20 cm.

ES - Estante cesta
GB - Basket shelf
FR - Etagère corbeille
DE - Korb-Fachregal
IT - Scaffale cest piano
PO - Prateleira/Cesto

D



ST/94291 45 x 90 x 15 cm.

ES - Estante cesta con boca
GB - Opened basket shelf
FR - Etagère corbeille avec ouverture
DE - Fachregal mit Eröffnung
IT - Scaffale cesta con apertura
PO - Prateleira/Cesto

E

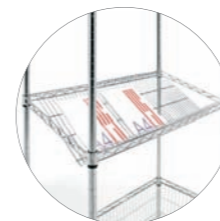

ST/97050 45 x 90 x 20 cm.

ES - Estante revistero inclinado
GB - Magazines shelf holder
FR - Etagère inclinée porte revues
DE - Geneigter Zeitungsständer
IT - Scaffale portariviste inclinato
PO - Prateleira inclinada para revistas

F



ST/97206 35 x 61 cm.
ST/97212 35 x 122 cm.

ES - Estante botellero
GB - Bottle holders
FR - Casier pour bouteilles
DE - Flaschenregal
IT - Portabottiglie
PO - Garrafeira

G



ST/97135 35 cm.
ST/97136 45 cm.

ES - Asa
GB - Handle
FR - Poignée
DE - Handgriff
IT - Manico
PO - Asa

H



ST/97910

ES - Soporte de pared
GB - Wall support
FR - Support mural
DE - Wandhalterung
IT - Supporto parete
PO - Suporte de parede

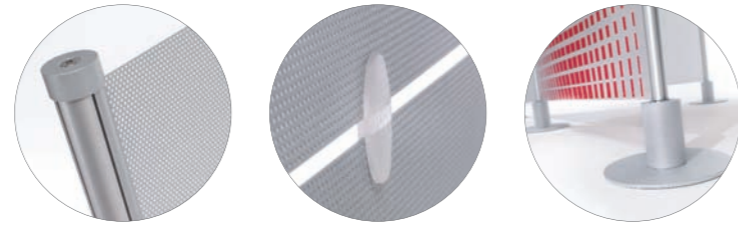

236

237

A
soporte

A	506/P1	126 x 25	3
B	506/P2	153 x 25	3
C	506/P3	183 x 25	3
D	506/P4	209 x 25	3

E	506/PP1	126 x 19	3
F	506/PP2	153 x 19	3
G	506/PP3	183 x 19	3
H	506/PP4	209 x 19	3

ES - Perfil de aluminio
GB - Aluminum profile
FR - Profil en aluminium
DE - Aluminiumprofil
IT - Profilo di alluminio
PO - Perfil de alumínio



B
panel

A	500/T	57 x 99	0,1
B	501/T	27 x 99	0,1
C	500/P	57 x 99	0,1
D	501/P	27 x 99	0,1
E	500/C	57 x 99	0,1
F	501/C	27 x 99	0,1
G	500/L	57 x 99	0,1

H	501/L	27 x 99	0,1
I	500/O	57 x 99	0,1
J	501/O	27 x 99	0,1
K	500/A	57 x 99	0,1
L	501/A	27 x 99	0,1
M	500/MPF	57 x 99	0,1
N	501/MPF	27 x 99	0,1

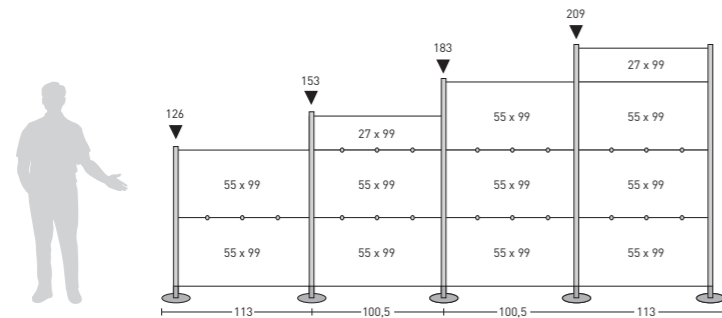
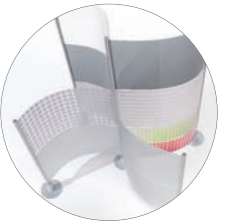
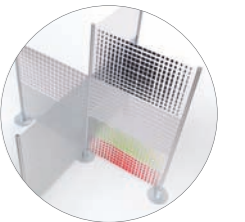

ES | Mamparas modulares flexibles "Slalom"
Sistema de mamparas modulares flexibles ideado para crear ambientes y separaciones de manera elegante, funcional y con estilo. La base es de acero pintado en gris y los paneles son de PVC (ignífugo) flexible a 360°, en diversos colores y texturas.

FR | Cloisons modulables et flexibles "Slalom"
Système de cloisons modulables et flexibles. Idéal pour créer des espaces délimités de manière élégante, fonctionnelle et avec style. La base est en acier peint en gris et les panneaux sont en PVC "ignifugés" et flexibles à 360°. Cloisons disponibles en différents coloris et motifs.

IT | Sistema divisorio modulare "Slalom"
Sistema divisorio modulare e flessibile, ideale per dividere gli spazi di lavoro, d'attesa o angoli pausa caffè...con uno stile moderno ed elegante. La base è in acciaio grigio. I pannelli sono in PVC (ignifugo) flessibile a 360°, disponibili in differenti colori e texture.

GB | Modular flexible partition boards "Slalom"
Modular flexible partition boards designed to create elegant atmospheres and divisions. The base which is made of steel painted in grey, the plastic profile and the 360° flexible PVC panels (fire-proof)- available in different colours and textures.

DE | Modular Moderatorentafeln "Slalom"
Dieses modular Moderatorentafeln-System besteht aus mehrfachen Tafeln, die zwischen Aluminiumsenkrechten für das Teilen eines Bereiches überspannen. Die Tafeln sind 360° flexibel und aus feuerfest PVC hergestellt.

PO | Biombos modulares flexíveis "Slalom"
Sistema modular de biombos modulares flexíveis idealizado para criar ambientes e separações de uma forma elegante. A base é de aço pintado na cor cinzenta e os painéis são de PVC (ignífugo) flexível a 360°. Propostos em diversas cores e texturas.

C
conector

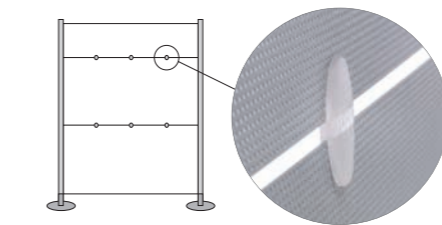

510/C	4,5 x 2,7	0,5
-------	-----------	-----

D
paragüero

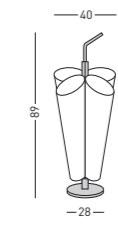

A	512/NG	89 x 40
B	512/AZ	89 x 40
C	512/RJ	89 x 40
D	512/VD	89 x 40



A	B	C	D	E	F	G	H	I	J	K	L	M	N
ES - Traslúcido	ES - Textura puntos	ES - Textura cuadros	ES - Textura líneas	ES - Textura óptica	ES - Ahumado	ES - Chapa microperforada							
GB - Translucent	GB - Point texture	GB - Square texture	GB - Line texture	GB - Optical texture	GB - Smoked	GB - Microperforated metal							
FR - Translucide	FR - Motif points	FR - Motif carrés	FR - Motif lignes	FR - Motif optique	FR - Fumé	FR - Métallique microperforé							
DE - Lichtdurchlässige	DE - Punkt-Gewebe	DE - Quadratgewebe	DE - Liniengewebe	DE - Optische Gewebe	DE - Rauchfarbig	DE - Microperforiertem Blech							
IT - Opaline	IT - Texture a punti	IT - Texture a quadri	IT - Texture a righe	IT - Texture a righe	IT - Fumè	IT - Metallo microforato							
PO - Translúcido	PO - Textura pontos	PO - Textura quadrados	PO - Textura linhas	PO - Textura óptica	PO - Fumado	PO - Chapa microperforada							



* ECOFLEX

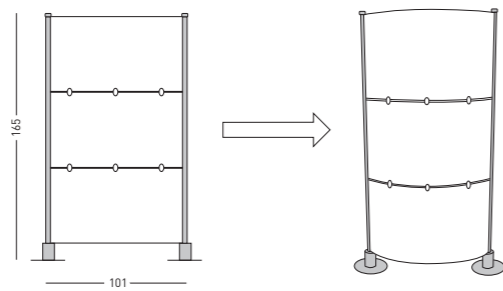

ES | Mamparas modulares flexibles "Slalom"
Sistema de mamparas modulares flexibles ideado para crear ambientes y separaciones de manera elegante, funcional y con estilo. La base es de acero pintado en gris y los paneles son de PVC (ignífugo) flexible a 360°, en diversos colores y texturas.

GB | Modular flexible partition boards "Slalom"
Modular flexible partition boards designed to create elegant atmospheres and divisions. The base which is made of steel painted in grey, the plastic profile and the 360° flexible PVC panels (fire-proof)- available in different colours and textures.

FR | Cloisons modulables et flexibles "Slalom"
Système de cloisons modulables et flexibles. Idéal pour créer des espaces délimités de manière élégante, fonctionnelle et avec style. La base est en acier peint en gris et les panneaux sont en PVC "ignifugés" et flexibles à 360°. Cloisons disponibles en différents coloris et motifs.

DE | Modular Moderatorentafeln "Slalom"
Dieses modular Moderatorentafeln-System besteht aus mehrfachen Tafeln, die zwischen Aluminiumsenkrechten für das Teilen eines Bereiches überspannen. Die Tafeln sind 360° flexibel und aus feuerfest PVC hergestellt.

IT | Sistema divisorio modulare "Slalom"
Sistema divisorio modulare e flessibile, ideale per dividere gli spazi di lavoro, d'attesa o angoli pausa caffè...con uno stile moderno ed elegante. La base è in acciaio grigio. I pannelli sono in PVC (ignifugo) flessibile a 360°, disponibili in differenti colori e texture.

PO | Biombos modulares flexíveis "Slalom"
Sistema modular de biombos modulares flexíveis idealizado para criar ambientes e separações de uma forma elegante. A base é de aço pintado na cor cinzenta e os painéis são de PVC (ignífugo) flexível a 360°. Propostos em diversas cores e texturas.

A
soporte

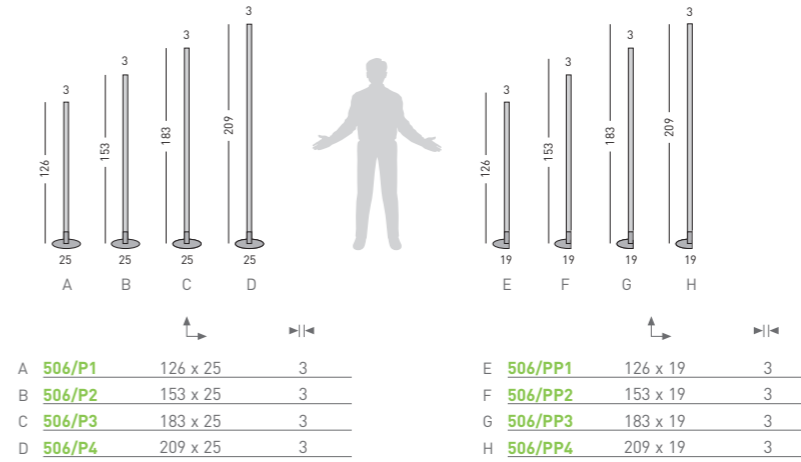

ES - Perfil de aluminio
GB - Aluminum profile
FR - Profil en aluminium
DE - Aluminiumprofil
IT - Profilo di alluminio
PO - Perfil de alumínio



B
ECOFLEX
panel

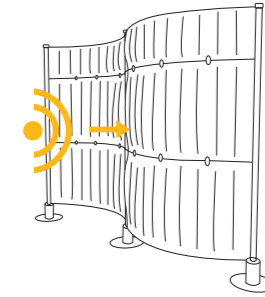
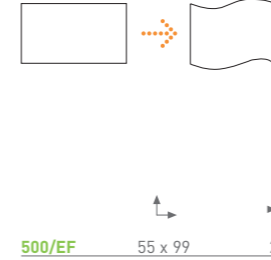

ES - Absorción del sonido
GB - Acoustic absorption
FR - Absorption acoustique
DE - Schallschluckend
IT - Assorbimento acustico
PO - Absorção de som

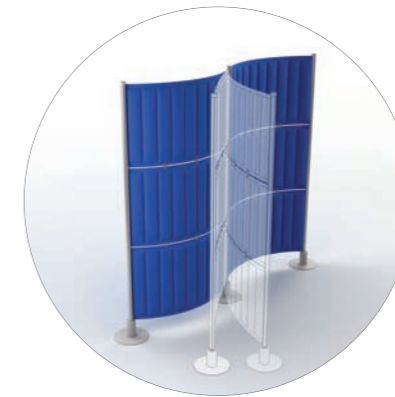

C
conector

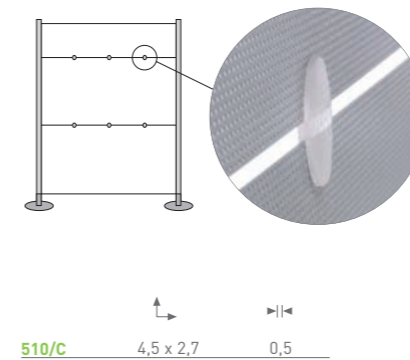

LIMIT 1

PS design



A soporte

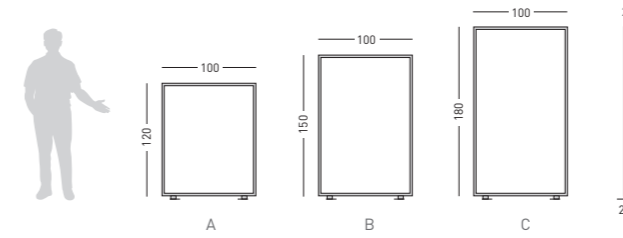

A	300/1/PI	122	120 x 100	2
B	300/2/PI	152	150 x 100	2
C	300/3/PI	182	180 x 100	2



ES - Pizarra blanca LM DE - XX
GB - XX IT - XX
FR - XX PO - XX

A	300/1/PX	122	120 x 100	2
B	300/2/PX	152	150 x 100	2
C	300/3/PX	182	180 x 100	2



ES - Polycarbonato DE - Polycarbonat
GB - Polycarbonate IT - Polycarbonato
FR - Polycarbonate PO - Polycarbonato

A	300/1/T/BL	122	120 x 100	2
B	300/2/T/BL	152	150 x 100	2
C	300/3/T/BL	182	180 x 100	2



ES - Laminado blanco DE - Weiß lamelliert
GB - White laminated IT - Bianco laminato
FR - Melamine blanc PO - Laminado branco

A	300/1/T/GR	122	120 x 100	2
B	300/2/T/GR	152	150 x 100	2
C	300/3/T/GR	182	180 x 100	2

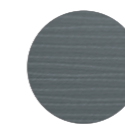

ES - Laminado gris DE - Grau lamelliert
GB - Grey laminated IT - Grey laminato
FR - Laminé gris PO - Laminado cinzento

A	300/1/T/NG	122	120 x 100	2
B	300/2/T/NG	152	150 x 100	2
C	300/3/T/NG	182	180 x 100	2

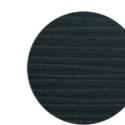

ES - Laminado negro DE - Schwarzes lamelliert
GB - Black laminated IT - Nero laminato
FR - Laminé noir PO - Laminado preto

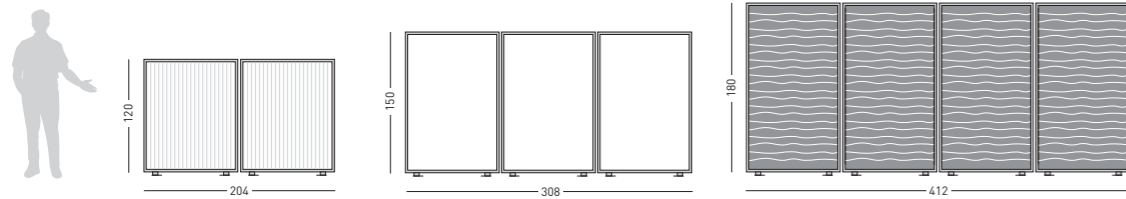

B kit unión 2 vías



300/K	2 x 5	2
-------	-------	---

C kit unión 4 vías



300/K/4	5 x 5	4
---------	-------	---



ES | Mampara modular "Limit"

Mampara modular "Limit" fabricada con perfil de aluminio anodizado mate y pies trapecoidales metálicos pintados en gris. Su sistema de unión permite ser graduable y abrir y cerrar con la apertura de grados necesaria.

FR | Cloison modulaire "Limit"

Cloison modulaire avec structure en aluminium et pieds métalliques. Modulable pour configurations en ligne, en quinconce... Panneaux en plexy canulé, métal gris ou laminé noir en relief.

IT | Divisorio modulare "Limit"

Lavagna modulare "Limit" fabbricata con cornice in alluminio e sostegni metallici. Il suo sistema di unione permette di essere graduabile ed aprire e chiudere in base al livello di apertura desiderato.

GB | Modular partition "Limit"

Modular partition with aluminium structure and metallic supports. Different layouts possible: in a line or in staggered rows... Panels in ribbed plexy, grey metal or black laminated in relief.

DE | Spanische Wand "Limit"

Spanische Wand "Limit" mit Aluminiumrahmen und Metallfüßen. Durch seine Verbindungsmöglichkeit ist es beliebig zusammensetzbar, verstellbar, an beliebiger Stelle zu öffnen und zu schließen. Verfügbar mit Plexi(gerippt) grau -metallisch und schwarz.

PO | Biombo modular "Limit"

Biombo modular "Limit", fabricado com perfil em alumínio e pés metálicos. O seu sistema de união permite ser ajustável e abrir e fechar com o grau necessário. Disponível com o interior em polipropileno alveolar, metálico cinzento e laminado em 3 cores.

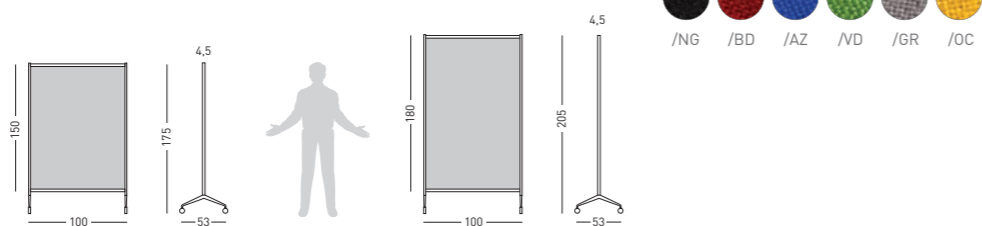

	↔	↑	↔
TL/150/PI	100 x 150	175	4,5
TL/180/PI	100 x 180	205	4,5

	↔	↑	↔
TL/150/T	100 x 150	175	4,5
TL/180/T	100 x 180	205	4,5

	↔	↑	↔
TL/150/PX	100 x 150	175	4,5
TL/180/PX	100 x 180	205	4,5

ES | Mampara Ten-Limit modular

Sistema de mampara modular fabricada con perfil de aluminio color plata y estructura provista de pies de fundición con ruedas y freno. Disponible en pizarra blanca laminada rotulable, policarbonato acanulado y tapizada disponible en 6 colores.

FR | Cloison Ten-Limit modulaire

Système de cloison modulaire sur cadre en aluminium et pieds en fonte gris, équipés de roulettes et de freins. Disponible en finition tableau blanc stratifié, polycarbonate rainuré et disponible en 6 couleurs de tissus.

IT | Schermo divisorio Ten-Limit modular

Sistema di schermi modulari realizzato con profilo di alluminio color argento e struttura dotata di basamento in funzione di alluminio con ruote e freni. Disponibile con lavagna bianca laminata scrivibile e tappezzata. Disponibile in 6 colori.

GB | Ten-Limit modular partition system

Modular partition system made of silver gray aluminium profile and a structure with cast feet fitted with wheels and brakes. Available with whiteboard laminated, corrugated polycarbonate and available in 6 colours of fabric.

DE | Spanische Wand

Spanische Wand gefertigt aus einem grauen Aluminiumrahmen, ausgelegt zum schieben auf Rollen, mit Bremse. Erhältlich mit weisser, beschreibbarer Tafel, oder in Hartplastik, gerppt und bespannt, in 6 Farben.

PO | Biombo Ten-Limit modulare

Sistema de biombos modulares fabricados com perfil em alumínio na cor prata e estrutura com pés com rodas. Disponível com quadro branco que permite a escrita, policarbonato canelado ou forrado com tecido disponível em 6 cores.

A
board



	↔	↑	↔
TL/150/PI	100 x 150	175	4,5
TL/180/PI	100 x 180	205	4,5



B
felt



	↔	↑	↔
TL/150/T	100 x 150	175	4,5
TL/180/T	100 x 180	205	4,5

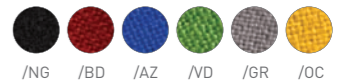

C
polycarbonate



	↔	↑	↔
TL/150/PX	100 x 150	175	4,5
TL/180/PX	100 x 180	205	4,5

SCREEN

PS design



A
soporte

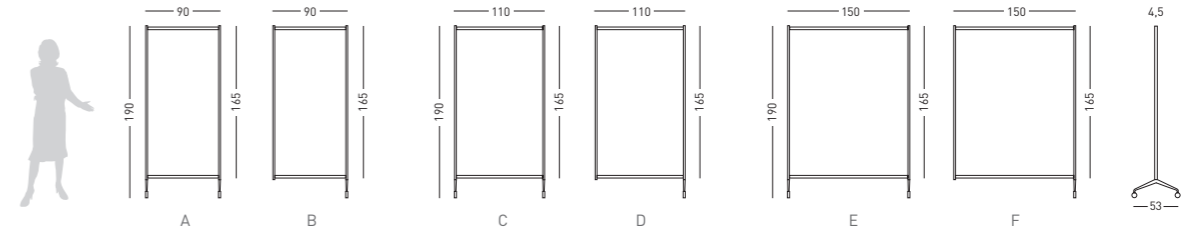

	↑↓	↙↘	↔	
A	SC/90/NG	190	165 x 90	4,5
B	SC/90/XF/NG	190	165 x 90	4,5
C	SC/110/NG	190	165 x 110	4,5
D	SC/110/XF/NG	190	165 x 110	4,5
E	SC/150/NG	190	165 x 150	4,5
F	SC/150/XF/NG	190	165 x 150	4,5



ES - Negro
GB - Black
FR - Noir
DE - Schwarzes
IT - Nero
PO - Preto

	↑↓	↙↘	↔	
A	SC/90/GR	190	165 x 90	4,5
B	SC/90/XF/GR	190	165 x 90	4,5
C	SC/110/GR	190	165 x 110	4,5
D	SC/110/XF/GR	190	165 x 110	4,5
E	SC/150/GR	190	165 x 150	4,5
F	SC/150/XF/GR	190	165 x 150	4,5

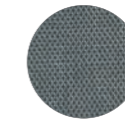

ES - Gris
GB - Grey
FR - Gris
DE - Grau
IT - Grigio
PO - Cinzento

	↑↓	↙↘	↔	
A	SC/90/CZ	190	165 x 90	4,5
B	SC/90/XF/CZ	190	165 x 90	4,5
C	SC/110/CZ	190	165 x 110	4,5
D	SC/110/XF/CZ	190	165 x 110	4,5
E	SC/150/CZ	190	165 x 150	4,5
F	SC/150/XF/CZ	190	165 x 150	4,5



ES - Personalizado
GB - Customized
FR - Personnaliser
DE - Angepasst
IT - Personalizzi
PO - Personalizado

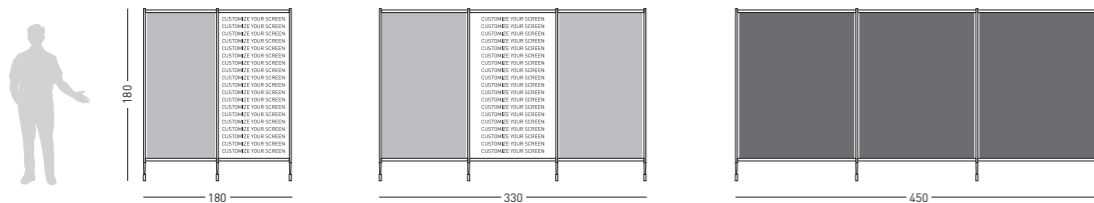
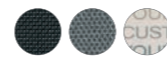

ES | Mampara modular "Screen"

Mampara modular "Screen" fabricada con perfil de aluminio "Ten" y pies de fundición del sistema "Y2". Su sistema de unión abisagrabable, permite abrir y cerrar con la apertura de grados necesaria. Disponible con screen (téltil) negro, gris y personalizable.

FR | Cloison modulaire "Screen"

Cloison modulaire "Screen" en profil aluminium "Ten" et piétement "Y2". Orientable pour configurations en ligne, en zig-zag... Disponible avec screen (toile) noire, grise et/ou personnalisable (sur demande).

IT | Divisorio modulare "Screen"

Lavagna modulare "Screen" fabbricata con cornice in alluminio "Ten" e basi in lega del sistema "Y2". Il suo sistema di unione a cerniera, permette di aprire e chiudere in base al livello di apertura desiderato. Disponibile in tessuto, nero, grigio e personalizzabile.

GB | Aluminium partition "Screen"

Modular aluminium partition with "Y2" support. Different layouts possible: in a line, in zig-zag... Available with black, grey or customizable screen (canvas).

DE | Spanische Wand "Screen"

Spanische Wand "Screen" mit Aluminiumrahmen "Ten" und Metallstandfüßen "Y2". Durch seine Verbindungsmöglichkeit ist es beliebig zusammensetzbar, verstellbar und an beliebiger Stelle zu öffnen und zu schließen.

PO | Biombo modular "Screen"

Biombo modular "Screen", fabricado em perfil de alumínio "Ten" e pés do sistema "Y2". O seu sistema de união permite abrir e fechar com o grau necessário. Disponível em screen (tecido) preto, cinzento e personalizável (consultar).



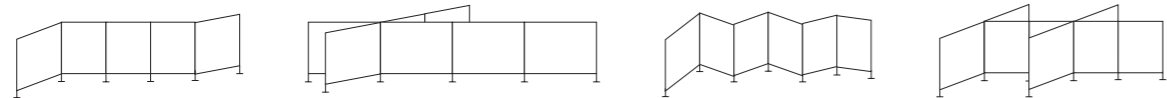
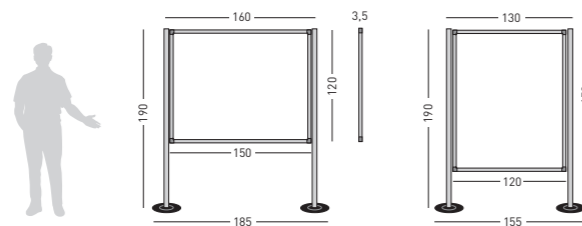

ES | Mampara modular

Mampara modular muy ligera, construida con un núcleo central de nido de abeja, enmarcada con perfil de aluminio con cantoneras de color gris y tapizado en textil por ambos lados. Amplia gama de aplicaciones como: Exposiciones, ferias, convenciones, etc.

FR | Cloisons modulaires

Cloison modulaire très légère fabriquée en carton nid d'abeille, avec encadrement en aluminium et coins en plastique gris. Montage et transport facile. Idéal pour les expositions, séparations d'espaces, foires, conventions, etc...

IT | Lavagna modulare

Leggere lavagne in pannello modulare con cornice alluminio ed angoli grigi e legno di fave. Semplice da trasportare e da montare in modo da utilizzarle in fiere, esposizioni, convegni, ecc. Possibile montare il supporto in verticale od orizzontale.

GB | Modulated felt boards

Light modulated felt boards with aluminium frame, grey corners and honeycomb wood. Double-sided felt board. Variety of applications, such as exhibitions, fairs, conventions, etc... Boards are 120 x 150 cm. and you can mount the support vertically or horizontally.

DE | Textil-moderationswände

Leichte Moderationstafeln mit Aluminium-Rahmen und abgerundeten Ecken. Diese hochwertigen und standsicheren Tafeln können vielseitig und mobil eingesetzt werden. Textil-Oberfläche beidseitig. Ideal für Präsentationen, Seminare oder Meetings,...

PO | Biombo modular

Biombo modular muito leve, construído com um núcleo central em ninho de abelha, e perfil em alumínio com cantos cinzentos. Permite dispor em qualquer momento de uma ampla gama de aplicações como: exposições, feiras, convênios, etc.

A
tapizado

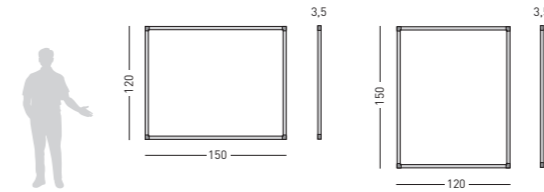

A	750/T/NG	120 x 150	3,5
B	750/T/AZ	120 x 150	3,5
C	750/T/BD	120 x 150	3,5
D	750/T/GR	120 x 150	3,5
E	750/T/VD	120 x 150	3,5
F	750/T/OC	120 x 150	3,5

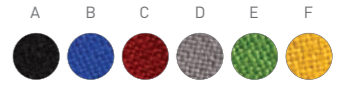

B
corcho

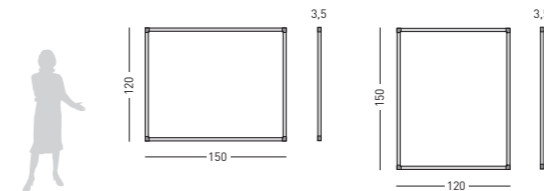

750/C	120 x 150	3,5
-------	-----------	-----



C
varios

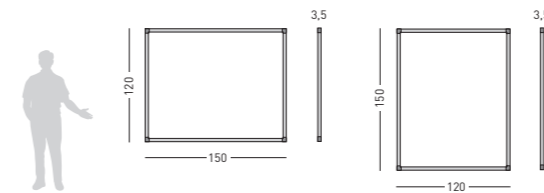

A	750/MG	120 x 150	3,5
B	750/P	120 x 150	3,5

A - Melamina gris / Laminated grey
B - Pizarra laminada blanca / Laminated whiteboard

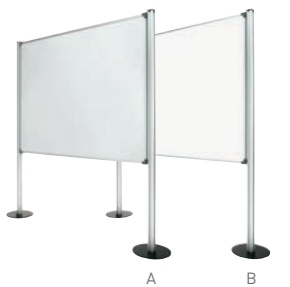

D
soporte

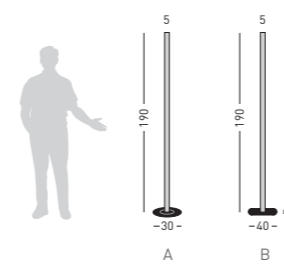

A	770/10	190 x 30	5
B	770/11	190 x 40	5

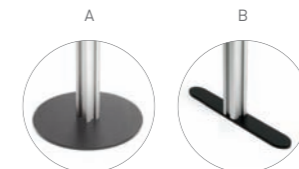



248



249

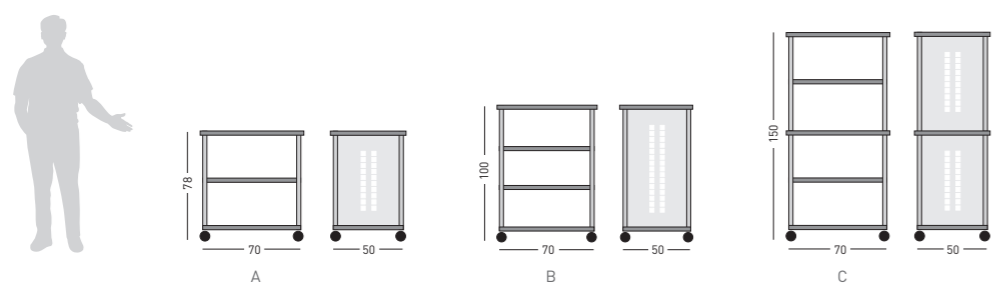

	↑	↙	?	
A	CAR/1	78	70 x 50	1
B	CAR/2	100	70 x 50	2
C	CAR/3	150	70 x 50	3

ES | Carros auxiliares

Carros auxiliares con ruedas (2 con freno), fabricados con perfil de aluminio anodizado en plata mate, laterales de chapa perforada del mismo color, sobre, base y estantes de madera melaminados en color haya. Disponibles en 3 tamaños con 1, 2 y 3 estantes.

FR | Chariots auxiliaires

Chariots auxiliaires sur roulette (dont 2 à freins) fabriqués avec une structure en aluminium anodisé couleur argent mat et plaques en métal latérales en perforées de la même couleur. La surface, la base et les étagères sont en bois mélaminés en couleur hêtre.

IT | Carrello ausiliario

Carrello ausiliario (2 ruote con freno) con struttura in alluminio anodizzato ed perforato nei lati della stessa finitura. Il top, la base ed i piani sono in faggio. Disponibile in 3 misure rispettivamente con 1, 2, 3 mensole. Ante apribili e chiusura con chiave.

GB | Auxiliary trolleys

Auxiliary Trolleys 4 wheels (2 with brakes) manufactured with silver aluminium anodised structure and perforated lateral metallic plates in the same colour. The top, base and shelf are made of beech-coloured melaminated wood. Available with 1, 2 and 3 shelves.

DE | Beistellwagen

Variabel nutzbarer Beistellwagen. Insbesondere auch für Multifunktionsgeräte geeignet. Aus anodisierter Aluminiumstruktur mit durchlöcherter Aluminium-Blech. Das Pult, der Unterbau und die Ablagefächer sind aus Melamin-beschichtete.

PO | Carro auxiliar

Carros auxiliares com rodas (2 com travão), fabricados com perfil em alumínio anodizado na cor prata mate, laterais em chapa de alumínio perfurada da mesma cor, sobre base e prateleiras em melamina na cor faia. Disponíveis em 3 tamanhos.

ES | Atril para conferencias

Atril para conferencias fabricado con estructura de aluminio anodizado en plata mate y plancha perforada del mismo color. El sobre inclinado, la base y el estante son de madera de haya. La base incluye 4 niveladores regulables en altura.

GB | Conference lecterns

Conference lecterns manufactured with silver aluminium anodised structure and perforated plate in the same colour. The inclined top, base and shelf are made of beech wood. The base contains 4 adjustable levelings to level out the ground drops.

FR | Pupitre pour conférences

Pupitre de conférences fabriqué avec une structure en aluminium anodisée de couleur argent mat. La tablette inclinée ainsi que la base sont en bois d'hêtre. La base à 4 niveleurs réglables en hauteur. Idéal pour les salles de formation, de conventions,...

DE | Rednerpult

Rednerpult aus stabiler anodisierter mit durchlöcherter Aluminium-Blech. Das schräge Pult, der Unterbau und das Regal sind aus Buchenholz. Mit höhenverstellbaren höhenverstellbare Bodengleitern, um Ungleichgewichte auszugleichen.

IT | Leggio in alluminio per conferenze

Leggio in alluminio fabbricato in alluminio anodizzato silver e lamiera microforata nella stessa finitura. Il top inclinato, la base e la mensola sono in legno di faggio. La base contiene 4 piedini di livellamento. Ideale per sale corsi, conventions, auditorium ed hotel.

PO | Púlpito para conferencias

Púlpito para conferencias fabricado com perfil em alumínio anodizado na cor prata mate e chapa de alumínio perfurada da mesma cor. O tampo é inclinado, a base e a prateleira são de melamina na cor faia. A base inclui 4 niveladores reguláveis em altura.

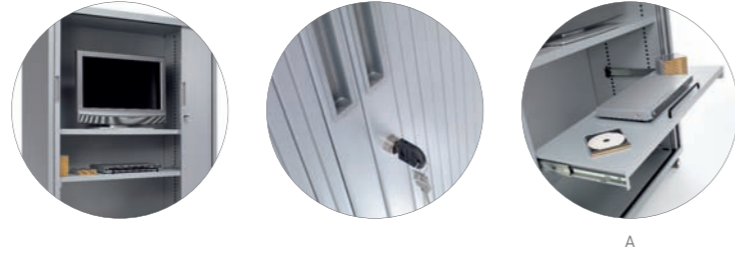

A



250



251

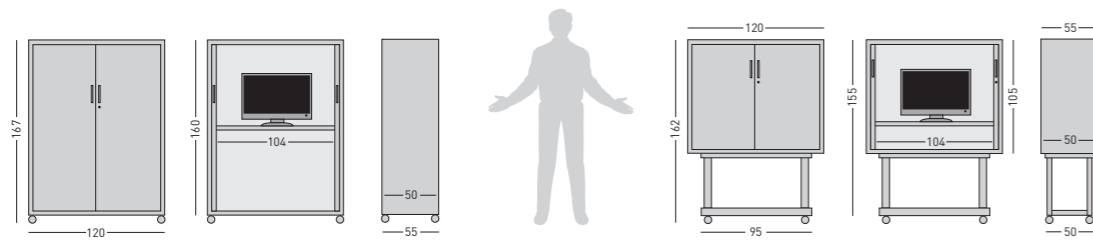

	757/PG	167 x 120 x 55	150 x 104 x 50	1
A	757/BAN	104 x 35 x 3	-	-

	757/PP	162 x 120 x 55	95 x 104 x 50	1
--	--------	----------------	---------------	---

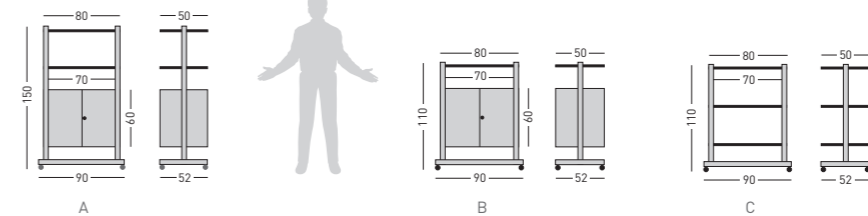

	A	755/B2	150 x 90	56 x 66 x 48	50 x 70	2
	B	755/B1	110 x 90	56 x 66 x 48	50 x 70	1
	C	756/B3	110 x 90	-	50 x 70	3

ES | Armario para audiovisuales

Armario de persiana para audiovisuales con ruedas dobles reforzadas de diseño (2 con freno), provistos de estante y cerradura con llave. La estructura, el cuerpo del armario metálico y la persiana es de color gris. Ideales para salas de formación, escuelas, etc...

FR | Armoire pour audiovisuels

Armoire a rideaux pour matériels audiovisuels sur 4 roulettes design doubles équipées de 2 freins, fourni avec de tablette intérieure et une serrure à clé. L'ensemble de l'armoire est en métal de couleur gris. Idéal pour des salles de classe, formation, etc...

IT | Consolle per audio-video

Consolle per sistemi audio video, con doppie ruote rinforzate di design (con 25 freni), mensole più basse e serratura. Colore grigio. Ideale per sale corsi, scuole, ecc, dove si necessita di aver materiale da chiudere.

ES | Armarios para audiovisuales con estantes

Conjunto formado por una estructura metálica pintada en color gris, provisto de ruedas (2 con freno), con un armario con puertas y cerradura situado en su parte baja y estantes melaminados de color gris canteados con PVC antichoque.

FR | Armoires et tablettes audiovisuels

Armoire avec une structure métallique de couleur grise, roulettes à frein, porte avec serrure. Les tablettes mélaminées grise avec coins antichoc sont réglables en hauteur sur les supports latéraux. Idéal pour les salles de formation, réunions, etc...

IT | Armadietto per TV/Video

Armadietto metallico grigio con ruote, freni, ante che si chiudono con chiave, bracci modulari che permettono di muovere le mensole verticalmente nella posizione desiderata. Ideale per TV, DVD, VCR, e supporti audio-video. Disponibile con 1 o 2 mensole.

GB | Blind cabinet audiovisuals

Blind cabinet for audiovisuals, provided with double castors reinforced with design (2 with brake), lower shelf and a key lock. The cabinet framework and the blind are grey. Ideal for training rooms, schools, etc... where the material is bound to be locked up.

DE | Rolladen-Schrank für Audiomaterial

Rolladen-Schrank für Audiomaterial mit doppelten verstärkten Rollen (2 mit Bremsen), Mittelböden und Sicherheitsschlüssel. Grau, metallische Struktur und graue Rolladen. Ideal für Ausbildungsstätte, etc.,... worin das Material abgeschlossen werden muß.

PO | Armário para audiovisuais

Armário de persiana para audiovisuais com rodas duplas reforçadas (2 com travão), com prateleira interior e fechadura com chave. A estrutura, o corpo de armário metálico e a persiana são na cor cinzenta. Ideais para salas de formação, escolas, etc...

GB | Audiovisual stands with cabinet

Grey metallic stands with castors and brakes have metallic adjustable braces that allow you to move shelves (lined with anti-shock PVC) vertically to their desired position as well as a cabinet that locks with key. Ideal for TV, VCR, DVD and audio visual equipment.

DE | Mobiles multimedia cabinet

Multimediale Vorführstation (Hellgrau). Mit 4 Rollen (2 feststellbar) und Unterschrank mit melamierten höheverstellbaren grauen Regalböden ausgestattet. 2 abschließbare Doppeltüren mit Schloss. Ideal für TV und Videorecorder, Daten-/Videoprojektor.

PO | Armário para audiovisuais

Conjunto formado por uma estrutura metálica pintada na cor cinzenta, com rodas (2 com travão), com um armário com uma prateleira, portas e fechadura, situado na parte de baixo do armário e prateleiras melaminadas na cor cinzenta e frisos em PVC.

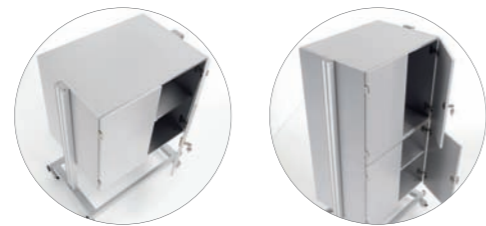

252

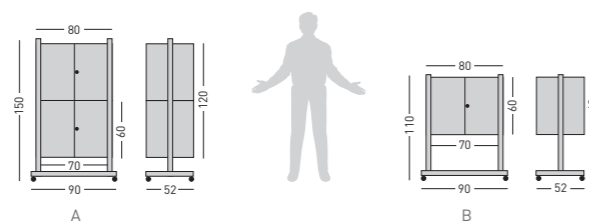

A	755/AP	150 x 90	56 x 66 x 48	2
B	755/BP	110 x 90	56 x 66 x 48	1

ES | Armario para audiovisuales

Conjunto formado por una estructura de aluminio y metálica pintada en color gris, provisto de ruedas (2 con freno), con un armario con estante provisto de puertas y cerradura. Ideales para TV y vídeo, DVD y equipos audiovisuales en salas de formación, reuniones,...

FR | Caissons audiovisuels

Armoire avec une structure métallique de couleur grise, roulettes à frein, porte avec serrure. Les tablettes mélaminées grise avec coins antichoc sont réglables en hauteur sur les supports latéraux. Idéal pour les salles de formation, réunions, etc...

IT | Armadietto per TV & Video

Armadietto in legno laminato grigio con ruote, freni, ante che si chiudono con chiave, e robusta base in metallo grigio. Ideale per TV, DVD, VCR, e supporti audio-video. Disponibile in 2 modelli diversi (ad 1 o 2 armadietti ciascuno con un ripiano).

GB | Audiovisual cabinets

Grey laminated wood cabinet with castors, brakes, doors that lock with key and sturdy metallic base. Ideal for TV, VCR, DVD and audio visual equipment for classrooms and offices. Available in 2 distinct models (1 and 2 cabinets, each has 1 interior shelf).

DE | Mobiles multimediacabinet

Multimediale Vorführstation (Hellgrau). Mit 4 Rollen (2 feststellbar) und Schrank mit Regalböden ausgestattet. 2 abschließbare Doppeltüren und Sicherheitschloss. Ideal für TV und Videorecorder, Daten-/Videoprojektor in Meetings, Hörsäle, etc.

PO | Armário para audiovisuais

Conjunto formado por uma estrutura metálica pintada na cor cinzenta, com rodas (2 com travão), com um armário com prateleira, portas e fechadura. Ideais para TV, Vídeo, DVD e equipamentos audiovisuais em salas de formação, reunião ou aulas.

253

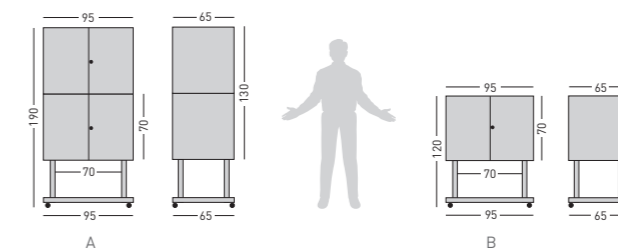

A	755/A/XL	190 x 95	66 x 91 x 61	2
B	755/B/XL	120 x 95	66 x 91 x 61	1

ES | Armario para audiovisuales "Extra grande"

Conjunto "Extra grande" formado por una estructura metálica pintada en color gris, provisto de ruedas reforzadas (2 con freno), con un armario con estante provisto de puertas y cerradura. Ideales para TV y vídeo, DVD y equipos audiovisuales en salas.

FR | Caissons audiovisuels "Extra grand"

Armoire avec une structure métallique de couleur grise et roulettes à frein, une tablette et serrure. Idéal pour les équipements audiovisuelles dans les salles de formation, réunions, etc...

IT | Armadietto per TV & Video "Extra grande"

Armadietto in legno laminato grigio con ruote, freni, ante che si chiudono con chiave, e robusta base in metallo grigio. Ideale per TV, DVD, VCR, e supporti audio-video. Disponibile in 2 modelli diversi (ad 1 o 2 armadietti ciascuno con un ripiano).

GB | "Extra large" audiovisual cabinets

Grey laminated wood cabinet with castors, brakes, doors that lock with key and sturdy grey metallic base. Ideal for TV, VCR, DVD and audio visual equipment for classrooms and offices. Available in 2 distinct models (1 and 2 cabinets, each has 1 interior shelf).

DE | Mobiles multimediacabinet "Extra große"

Multimediale Vorführstation (Hellgrau). Mit 4 feststellbare Rollen und Unterschrank mit einem Einlegeboden ausgestattet. Ideal für TV und Videorecorder, Daten-/Videoprojektor in Meetings, Hörsäle, etc.

PO | Armário "Extra grande"

Conjunto "Extra Grande" formado por uma estrutura metálica pintada na cor cinzenta, com rodas reforçadas (2 com travão), com um armário com prateleira, portas e fechadura. Ideais para TV, Vídeo, DVD e equipamentos audiovisuais em salas de formação, reunião ou aulas.

MESAS
PS design

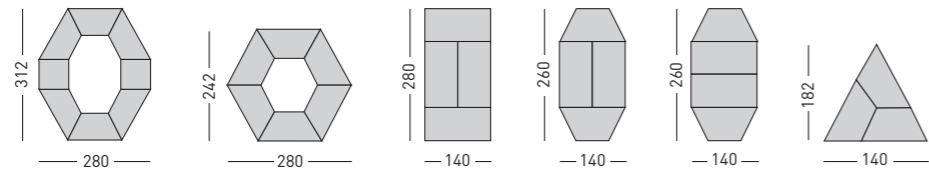

ES | Mesas modulares

Mesa modular fabricada con tablero melaminado gris o haya de 25 mm. Canteado con PVC de 3 mm. anti-choque. Patas de tubo de aluminio de 5 cm de diámetro y contera final regulable 5 cm., para corregir posibles desniveles del suelo. Disponibles en 3 formatos.

GB | Modular tables

Modular tables made with 25 mm. thick laminated grey wood table top (lined with anti-shock 3 mm. thick PVC). Aluminium supports are 5 cm. diameter and have a 5 cm. long metal tip to adjust for different floor levels. Available in 3 different formats.

FR | Tables modulaires

Tables modulaires en mélamine de 25 mm. d'épaisseur, grise avec coins de 3 mm, antichoc. Pieds en aluminium de couleur noire, 5 cm de diamètre et support final réglable sur 5 cm pour corriger les possibles dénivellements du sol. 3 formats différents.

DE | Beistelltische

Beistelltische aus melaminharzbeschichteter Spannplatte 25 mm., Farbe: Buchen. Aluminium-FüÙe in schwarzer Farbe 25 cm. Ø und regulierbare Stütze 5 cm., um die möglichen Unebenheiten des Bodens auszugleichen. Verfügbar in 3 verschiedenen.

IT | Tavololi modulares

Tavolo modulare fabbricato con laminato grigio da 25 mm. Spessore (con pvc antishock da 3 mm.). I supporti in alluminio sono di diametro 5 cm. ed hanno un piedino di livellamento di cm. 5 Disponibile in 3 formati diversi per ottenere multiple combinazioni.

PO | Mesas modulares

Mesa modular fabricada com tampo melaminado de 25 mm. na cor cinzenta ou faia com friso em PVC de 3 mm. anti-choque. Pés em tubo de alumínio com 5 cm. de diâmetro e nivelador ajustável. Disponível em 3 formatos.

A
gris

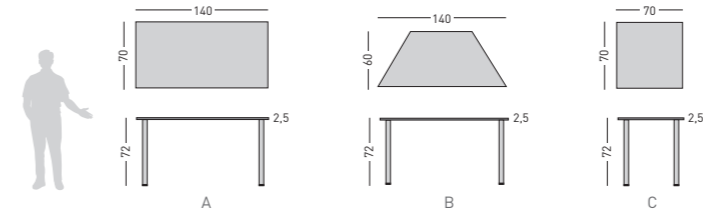

	↑	□	→	
A	MR/G	72	140 x 70	2,5
B	MT/G	72	140 x 60	2,5
C	MC/G	72	70 x 70	2,5



B
haya

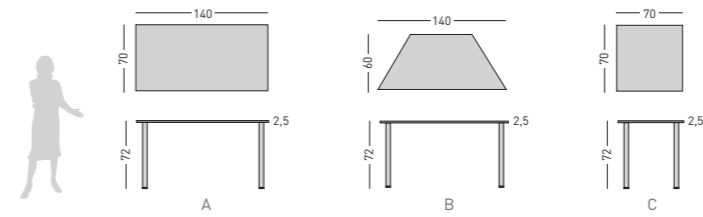

	↑	□	→	
A	MR/M	72	140 x 70	2,5
B	MT/M	72	140 x 60	2,5
C	MC/M	72	70 x 70	2,5



C
plegable



	↑	□	→	
A	MR/G/PP	72	140 x 70	2,5
B	MR/M/PP	72	140 x 70	2,5

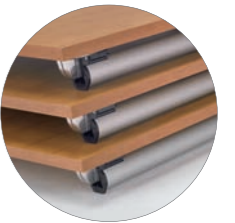

D
patas



	↑	→	
A	M/PP	70	5
B	M/PF/NG	70	5
C	M/PF/PL	70	5





256



NEW

/GR

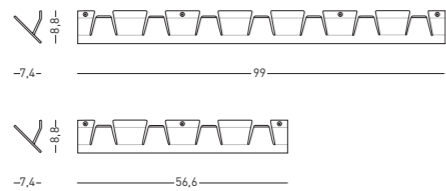

PR/F	8,8 x 7,4	99	7
PR/F4	8,8 x 7,4	56,6	4

ES | Perchero MILÚ

Perchero metálico mural de gran robustez, provisto de 7 perchas. Perfecto para uso en colectividades, salas, universidades etc. Disponible en color gris.

FR | Porte-manteau MILÚ

Porte-manteau en tube métallique peint en blanc. Barre supérieure réglable en hauteur. Châssis avec roulettes et plateaux en position inférieure.

IT | Appendiabiti MILÚ

Appendiabiti metallico da parete di grande robustezza, dotato di 7 ganci. Perfetto per l'utilizzo in collettività, sale conferenze, università, etc. Disponibile in colore grigio.

GB | MILU wall hanger

Strong and heavy use metal wall hanger, provided seven hangers. Perfect for use in communities, theatres, universities etc. Available in gray.

DE | Kleiderständer aus Metall

Robuster Kleiderständer aus Metall für 7 Bügel. Sehr geeignet für Gemeinschaftsräume, Säle, Universitäten etc. Farbe Grau.

PO | Cabide MILÚ

Cabide metálico de parede com grande robustez e 7 cabides. Perfeito para utilização em coletividades, salas, universidades etc. Disponível em cinzento.

257

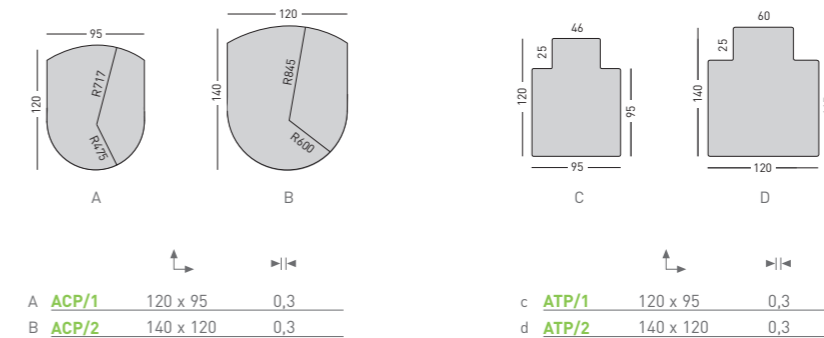

ES | Alfombras protectoras para suelos duros

Superficies protectoras para suelos duros (parquets, baldosas, etc.) fabricados con PET (polietileno tereftalato) de alta calidad, resistente y cómodo de pisar, para proteger el desgaste que sufren los parquets debido a la fricción de las ruedas de las sillas.

FR | Tapis pour sols durs

Tapis transparents fabriqués en PET (polyéthylène téréphthalique) de très bonne qualité. Résistant à l'usage et à l'usure des roulettes sur les moquettes et pour une période prolongée. Le revers est lisse pour les sols durs ou en parquets.

IT | Tappetino per sedie per pavimenti

Tappetino per sedie fabbricato in PET della qualità più resistente per pavimenti in legno e piastrellati. Resistente ai movimenti delle ruote per un lungo periodo di tempo. Il fondo antiscivolo con appositi agganci assicura la stabilità del tappetino.

GB | Transparent chairmats for hard floor

Transparent chairmats for Hard Floors (parquets, floor tiles, etc) made with PET (Polyethylene Terephthalate) of the utmost quality. Resistant to the wear and tear of chair castors over an extended period of time.

DE | Schutzmatte für Teppichboden (harte boden)

Schutzmatte für Teppichboden (harte Boden: Parkettfußboden, Bodenfliese...), in PET von hoher Qualität hergestellt und sehr bequem zu betreten. Widerstandsfähig gegen den Gebrauch und der Abnutzung der Stuhlrollen auf dem Parkett.

PO | Protector de piso duro

Superficies protectoras para piso duro (parquets, mosaicos, etc.), fabricadas com PET (polietileno tereftalato) de alta qualidade, resistente e cómodo ao pisar, para proteger do desgaste que sofrem os pisos rígidos devido à fricção das rodas das cadeiras.



258



A



B - C



D - F







* Bateria no incluída
* Battery not included

NEW

259



* Bateria no incluída
* Battery not included

					
A	B	C	D	E	F
BL/MO/0100	RE/MU/25	RE/MU/30	RE/AC/26	RE/AC/31	RE/AC/38
35	25	30	26	31	38
4,5	4	4	4	4	4

		
A	B	C
RE/CT/31/BCN	RE/ME/38	RE/ME/60
31	38	60
4	5,5	5,5
BARCELONA		
RE/CT/31/MAD	RE/ME/75	
31	75	
4		
MADRID		
RE/CT/31/LON		
31		
4		
LONDRES		
RE/CT/31/NY		
31		
4		
NEW YORK		
RE/CT/31/XX		
31		
4		
PERSONALIZE		

ES | Reloj mural "Time"

Colección de relojes fabricados en plástico y metal de alta calidad. Disponibles en varios tamaños, colores y diferentes acabados. Ideales para oficinas, colectividades y ambientes comunes.

FR | Horloge murale "Time"

Collection d'horloges en plastique et métal de très bonne qualité. Disponibles en plusieurs couleurs, dimensions et finitions. Idéal pour le bureau, les parties communes et publiques.

IT | Orologio da parete "Time"

Collezione di orologi fabbricati in plastica e metallo di alta qualità. Disponibili in vari formati, colori e diverse rifiniture. Ideali per uffici collettivi e ambienti comuni.

ES | Reloj mural "Time"

Colección de relojes fabricados en plástico y metal de alta calidad. Disponibles en varios tamaños, colores y diferentes acabados. Ideales para oficinas, colectividades y ambientes comunes.

FR | Horloge murale "Time"

Collection d'horloges en plastique et métal de très bonne qualité. Disponibles en plusieurs couleurs, dimensions et finitions. Idéal pour le bureau, les parties communes et publiques.

IT | Orologio da parete "Time"

Collezione di orologi fabbricati in plastica e metallo di alta qualità. Disponibili in vari formati, colori e diverse rifiniture. Ideali per uffici collettivi e ambienti comuni.

GB | Wall clock "Time"

High quality clock range made of metal and plastic. Available in various colours, sizes and finishes. Suitable for offices and public/private places.

DE | Wanduhr "Time"

Sammlung von Uhren aus Kunststoff und Metall-Qualität hergestellt. Erhältlich in verschiedenen Größen und Farben und Oberflächen. Ideal für Büros, lokale und gebräuchlichen Umgebungen.

PO | Relógio de parede "Time"

Coleção de relógios, fabricados em plástico e metal de alta qualidade. Disponível em vários tamanhos, cores e acabamentos. Ideais para escritórios, associações e ambientes comuns.

GB | Wall clock "Time"

High quality clock range made of metal and plastic. Available in various colours, sizes and finishes. Suitable for offices and public/private places.

DE | Wanduhr "Time"

Sammlung von Uhren aus Kunststoff und Metall-Qualität hergestellt. Erhältlich in verschiedenen Größen und Farben und Oberflächen. Ideal für Büros, lokale und gebräuchlichen Umgebungen.

PO | Relógio de parede "Time"

Coleção de relógios, fabricados em plástico e metal de alta qualidade. Disponível em vários tamanhos, cores e acabamentos. Ideais para escritórios, associações e ambientes comuns.



260



NEW LED 1x5W 230V 2900K

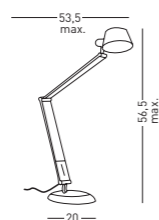

LAS/40/LD 56,5 20 5

ES | Lámpara sobremesa "Light"

Amplia gama de lámparas de diseño de sobremesa fabricadas en materiales y acabados actuales y de máxima calidad. Disponibles en bajo consumo, incandescencia, Led y power Led. Bombillas no incluidas.

FR | Lampe de bureau "Light"

Large gamme de lampes de table design, fabriquées avec des matériaux modernes, et aux finitions de haute qualité. Disponible en Led, Power-Led... Ampoules non fournis.

IT | Lampada da tavolo "Light"

Amplia gamma di lampade di design da tavolo fabbricate in materiali e rifiniture moderni e di massima qualità. Disponibili nelle versioni basso consumo, ad incandescenza, Led e Power Led. Lampadine non incluse.

PO | Candeeiro de mesa "Light"

Ampla gama de candeeiros para mesa de design, fabricados em materiais e acabamentos actuais e de máxima qualidade. Disponíveis em opção de baixo consumo, fluorescente, led e power led. Lâmpadas não incluídas.

GB | Table lamp "Light"

Large range of designed table lamps made of modern materials with high quality finishings. Available: low consume, Led, power led. Light bulb not included.

DE | Vielfalt aus Tischlampen "Light"

Vielfalt aus Tischlampen, aus verschiedenen Materialien, modernem Design und höchster Qualität. Verfügbar als verbrauchsarm, mit Glühbirnen, LED und POWER LED. Birnen nicht inklusive.

261



NEW LED 6,7W 3000K 4W 5500K

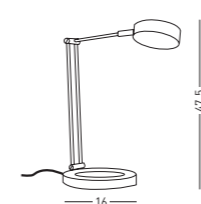

A LAS/41/LD 47,5 16 6,7

ES | Lámpara sobremesa "Light" (led)

Amplia gama de lámparas de diseño de sobremesa fabricadas en materiales y acabados actuales y de máxima calidad. Disponibles en bajo consumo, incandescencia, Led y power Led. Bombillas no incluidas.

FR | Lampe de bureau "Light" (led)

Large gamme de lampes de table design, fabriquées avec des matériaux modernes, et aux finitions de haute qualité. Disponible en, Led, Power-Led... Ampoules non fournis.

IT | Lampada da tavolo "Light" (led)

Amplia gamma di lampade di design da tavolo fabbricate in materiali e rifiniture moderni e di massima qualità. Disponibili nelle versioni basso consumo, ad incandescenza, alogene, Led e Power Led. Lampadine non incluse.

GB | Table lamp "Light" (led)

Large range of designed table lamps made of modern materials with high quality finishings. Available: low consume, Led, power led. Light bulb not included.

DE | Vielfalt aus Tischlampen "Light" (led)

Vielfalt aus Tischlampen, aus verschiedenen Materialien, modernem Design und höchster Qualität. Verfügbar als verbrauchsarm, mit Glühbirnen, LED und POWER LED. Birnen nicht inklusive.

PO | Candeeiro de mesa "Light" (led)

Ampla gama de candeeiros para mesa de design, fabricados em materiais e acabamentos actuais e de máxima qualidade. Disponíveis em opção de baixo consumo, fluorescente, led e power led. Lâmpadas não incluídas.



B LAS/22/LD 45 15 4



A B C



C



NEW POWER LED 2x5W



NEW G23-2x9W E27-20W



A LAS/12/BC 70 18 9



B LAS/14/BC 56 20 20

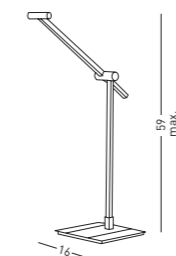

LAS/50/LD 59 16 38 2 x 5

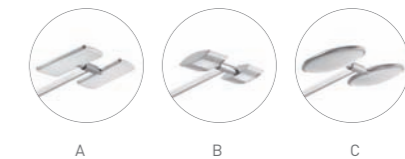

	Height	Width	Depth	W
A LAS/SPOT/01	13,5 x 10,5	0,8	-	5
B LAS/SPOT/02	11 x 6,5	1,6	-	5
C LAS/SPOT/03	15 x 3,1	-	12	5

ES | Lámpara sobremesa "Light"

Amplia gama de lámparas de diseño de sobremesa fabricadas en materiales y acabados actuales y de máxima calidad. Disponibles en bajo consumo, incandescencia, Led y power Led. Bombillas no incluidas.

FR | Lampe de bureau "Light"

Large gamme de lampes de table design, fabriquées avec des matériaux modernes, et aux finitions de haute qualité. Disponible en Led, Power-Led... Ampoules non fourni.

IT | Lampada da tavolo "Light"

Ampia gamma di lampade di design da tavolo fabbricate in materiali e rifiniture moderni e di massima qualità. Disponibili nelle versioni basso consumo, ad incandescenza, Led e Power Led. Lampadine non incluse.

ES | Lámpara sobremesa "Light" (power led)

Amplia gama de lámparas de diseño de sobremesa fabricadas en materiales y acabados actuales y de máxima calidad. Disponibles en bajo consumo, incandescencia, Led y power Led. Bombillas no incluidas.

FR | Lampe de bureau "Light" (power led)

Large gamme de lampes de table design, fabriquées avec des matériaux modernes, et aux finitions de haute qualité. Disponible en Led, Power-Led... Ampoules non fourni.

IT | Lampada da tavolo "Light" (power led)

Ampia gamma di lampade di design da tavolo fabbricate in materiali e rifiniture moderni e di massima qualità. Disponibili nelle versioni basso consumo, ad incandescenza, Led e Power Led. Lampadine non incluse.

GB | Table lamp "Light"

Large range of designed table lamps made of modern materials with high quality finishings. Available: low consume, Led, power led. Light bulb not included.

DE | Vielfalt aus Tischlampen "Light"

Vielfalt aus Tischlampen, aus verschiedenen Materialien, modernem Design und höchster Qualität. Verfügbar als verbrauchsarm, mit Glühbirnen, LED und POWER LED. Birnen nicht inklusive.

PO | Candeeiro de mesa "Light"

Ampla gama de candeeiros para mesa de design, fabricados em materiais e acabamentos actuais e de máxima qualidade. Disponíveis em opção de baixo consumo, fluorescente, led e power led. Lâmpadas não incluídas.

GB | Table lamp "Light" (power led)

Large range of designed table lamps made of modern materials with high quality finishings. Available: low consume, Led, power led. Light bulb not included.

DE | Tischlampen "Light" (power led)

Vielfalt aus Tischlampen, aus verschiedenen Materialien, modernem Design und höchster Qualität. Verfügbar als verbrauchsarm, mit Glühbirnen, LED und POWER LED. Birnen nicht inklusive.

PO | Candeeiro de mesa "Light" (power led)

Ampla gama de candeeiros para mesa de design, fabricados em materiais e acabamentos actuais e de máxima qualidade. Disponíveis em opção de baixo consumo, fluorescente, led e power led. Lâmpadas não incluídas.



A
screen

	↙ ↘	↔
SEP/1/80	40 x 80	4,6
SEP/1/120	40 x 120	4,6
SEP/1/140	40 x 140	4,6
SEP/1/160	40 x 160	4,6
SEP/1/180	40 x 180	4,6
SEP/1/200	40 x 200	4,6



265

B
screen
+
3rd.
level

	↙ ↘	↔
SEP/2/80	40 x 80	4,6
SEP/2/120	40 x 120	4,6
SEP/2/140	40 x 140	4,6
SEP/2/160	40 x 160	4,6
SEP/2/180	40 x 180	4,6
SEP/2/200	40 x 200	4,6



264

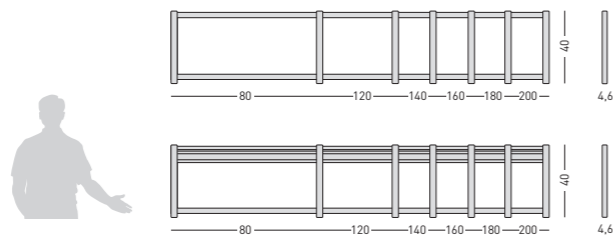
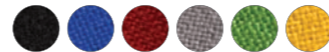

ES | Separador acústico

Colección de separadores de sobremesa acústicos tapizados con tela disponible en 6 colores. Estructura de aluminio disponible con perfil superior 3er nivel para adaptar complementos de sobremesa de la colección SIDNEY de Made Design.

FR | Séparateurs acoustiques

Collection de cloisons et séparateurs acoustiques de bureau, disponible en toile avec 6 couleurs au choix. Cadre en aluminium avec profil supérieur pour adapter le 3e niveau pour collection d'accessoires de bureau SIDNEY de Made Design.

IT | Separatore acustico

Collezione di separatori acustici da sopra-scrivania tappezzati con tessuto in 6 colori. Struttura di alluminio disponibile con profilo superiore a 3° livello per renderlo adattabile ai complementi di sopra-scrivania della collezione SIDNEY di Made Design.

GB | Acoustic desktop separator

Collection of acoustic desktop separators with 6 different colours of fabric. Aluminium framing with a top profile rail available to adapt a 3rd level desktop accessories from the collection Made Design SIDNEY.

DE | Auswahl von schallschluckenden Teilern

Auswahl von schallschluckenden Teilern für die Montage auf Tischen, mit Stoffbespannung in 6 Farben erhältlich. Das obere Teil lässt sich vervollständigen mit Tischzubehör aus der Kollektion "SIDNEY" von Made Design.

PO | Separador acústico

Coleção de separadores acústicos para secretária forrados com tecido disponível em 6 cores. Estrutura em alumínio que permite adaptar os complementos de mesa da coleção SIDNEY de Made Design.

X
access



A	SID/21	Bandeja A4 tercer nivel / Third level A4 letter tray
B	SID/22	Panel magnético tercer nivel / Third level magnetic panel
C	SID/23	Plumier tercer nivel / Third level pencil tray
D	SID/28	Porta post-it tercer nivel / Third level post-it holder
E	SID/40	Perfil para tercer nivel / Third level profile